

INTERLINE

INTERLINE BALI 8,40 x 4,90 m

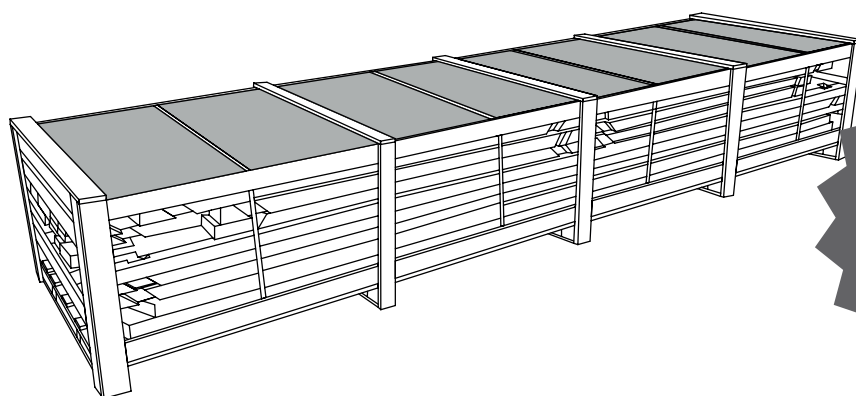
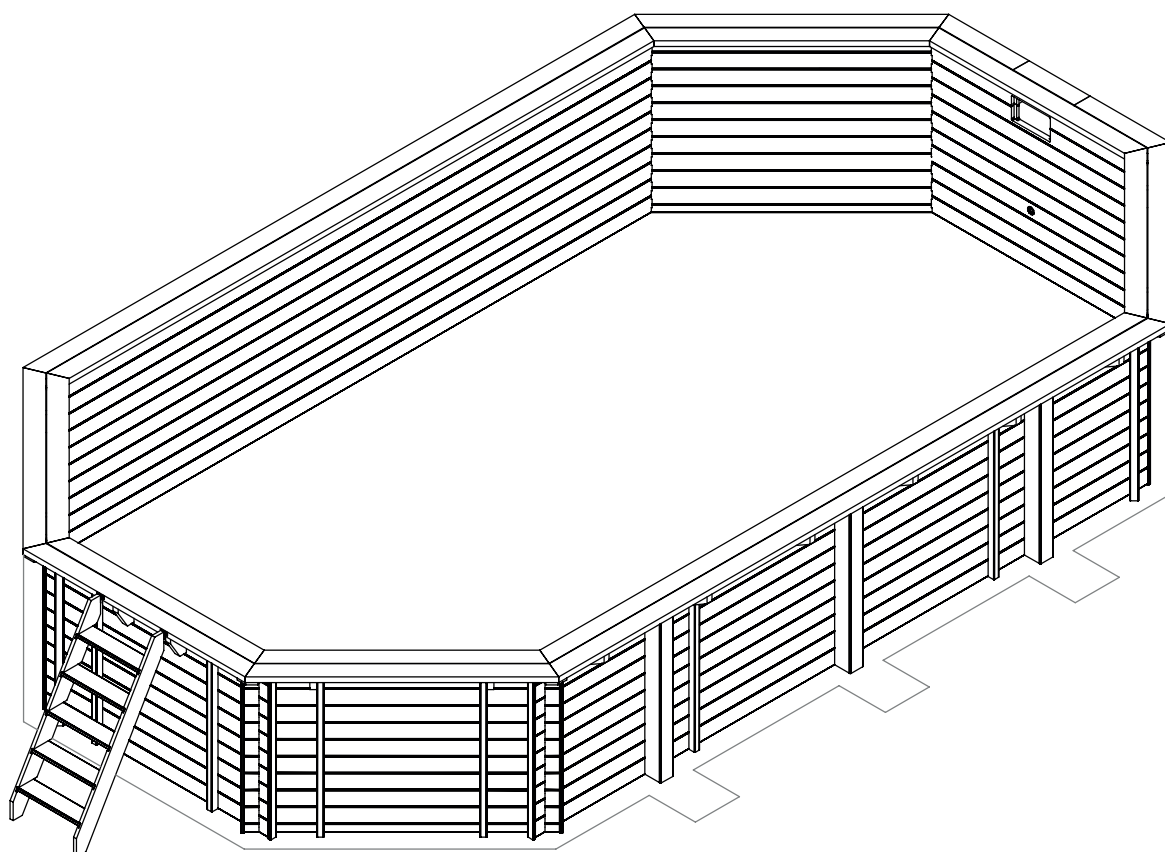

5 years
Wood warranty

- PL Instrukcja montażu
- FR Notice de montage
- GB Assembly instructions
- IT Istruzioni di montaggio
- DE Montageanleitung
- NL Montage-instructies

Objętość wody w basenie 37,24 m³
Le volume de l'eau dans la piscine 37,24 m³
Water capacity in the pool 37,24 m³
Il volume di acqua in piscina 37,24m³
Volumen von Wasser im Schwimmbecken 37,24 m³
Inhoud van het zwembad 37,24 m³

(PL) Instrukcja montażu

(GB) Assembly instructions

(D) Montageanleitung

(FR) Notice de montage

(IT) Istruzioni di montaggio

(NL) Montage-instructies



(PL) Przed przystąpieniem do montażu zapoznaj się z instrukcją. * Bez wylewki betonowej.

(FR) Avant le montage lisez attentivement la notice. * Sans la dalle en béton.

(GB) Read carefully pool installation manual before the installation. * Without concrete base.

(IT) Prima del montaggio è necessario consultare il manuale. * Senza una lastra di cemento.

(D) Vor der Montage machen Sie sich bitte mit der Bedienungsanleitung bekannt. * Ohne Betonestrich.

(NL) Lees aandachtig de montage instructie van het zwembad voor de installatie. Zonder betonnen sokkel.

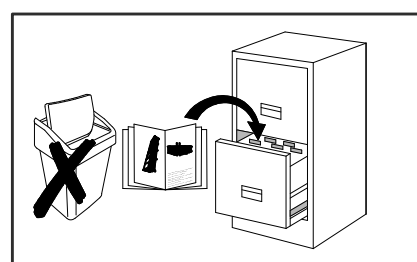
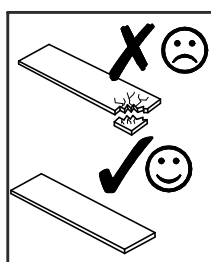
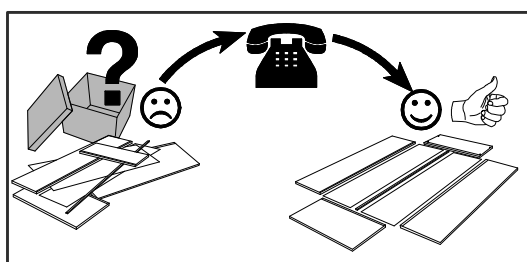
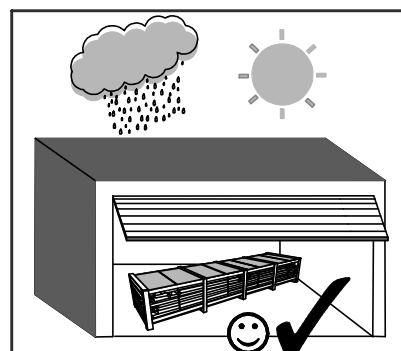
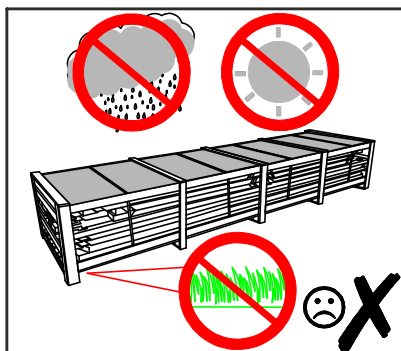
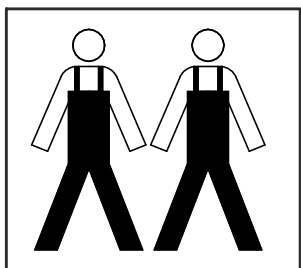
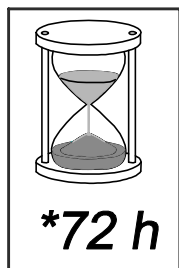

UWAGA /REMARQUE /NOTE/ ATATTENZIONE /HINWEIS /LETOP

(PL) Montaż wykonać w przeciągu 3 dni od rozpakowania struktury.

(FR) Il faut monter la structure au cours de 3 jours de l'ouverture du colis.

(GB) Installation should be finished within 3 days from opening the package.

(IT) Il montaggio effettuare entro 3 giorni dal disimballo della struttura.

(D) Die Montage ist innerhalb von 3 Tagen zu machen, nachdem die Konstruktion geöffnet wird.

(NL) De installatie moet worden afgewerkt binnen 3 dagen na het openen van de verpakking.

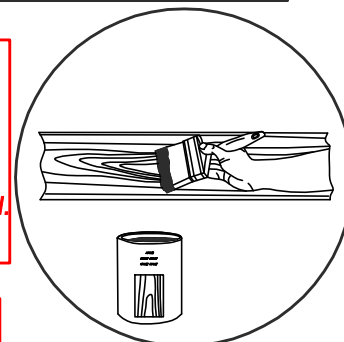

UWAGA /REMARQUE /NOTE/ ATATTENZIONE /HINWEIS /LETOP

(PL) Brak corocznej konserwacji struktury powoduje utratę gwarancji.

(FR) Le manque de la conseravtion annuelle de la structure cause la perte de la garantie.

(GB) Lack of once a year conservation of the structure causes loss of warranty.

(IT) Mancanza della manutenzione annuale causa la perdita di garanzia.

(D) Keine jährliche Wartung der Konstruktion macht das, das die Garantie verloren geht.

(NL) Behandel elk jaar de buitenkant van het zwembad met een beits, anders vervalt de garantie.



UWAGA /REMARQUE /NOTE/ ATATTENZIONE /HINWEIS /LETOP

(PL) Nie pozostawiać dzieci bez nadzoru!

(FR) Ne laissez pas les enfants sans surveillance !

(GB) Do not leave children unattended!

(IT) Non lasciare bambini incustoditi!

(D) Lassen Sie Kinder nicht unbeaufsichtigt!

(NL) Laat kinderen niet zonder toezicht!

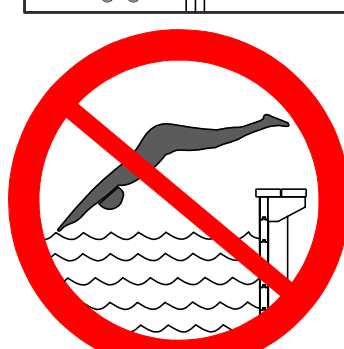
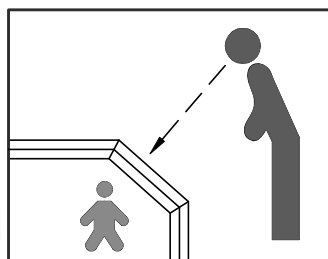

PL Elementy

GB Elements

D Elemente

FR Les éléments

IT Elementi

NL Balken



- PL** Sprawdź ilość oraz czy elementy nie są uszkodzone.
- FR** Vérifiez la quantité et si les éléments ne sont pas abîmés.
- GB** Check quantity of elements and if they are not faulty.
- IT** Controllare la quantità e se gli elementi non sono danneggiati.
- D** Sie die Menge, und ob die Elemente nicht beschädigt sind.
- NL** Controleer de aantal balken, en op eventuele beschadigingen.

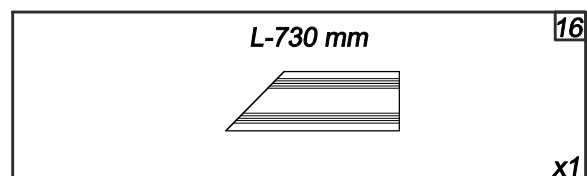
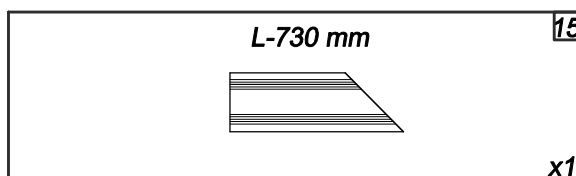
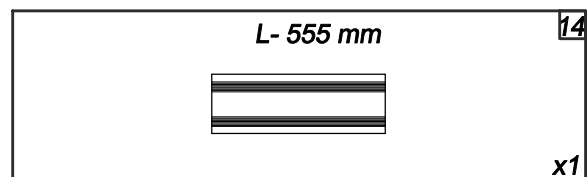
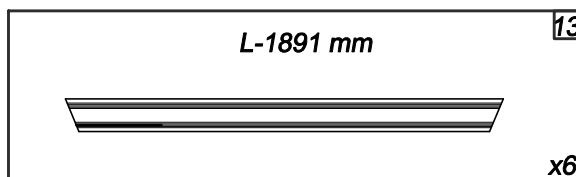
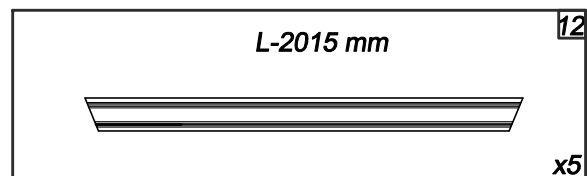
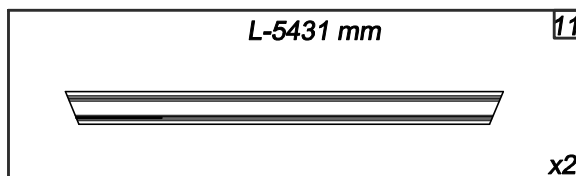
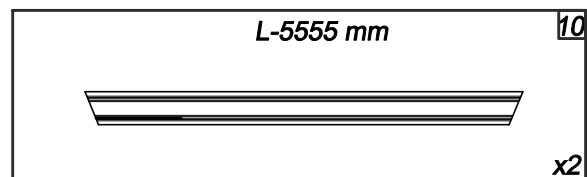
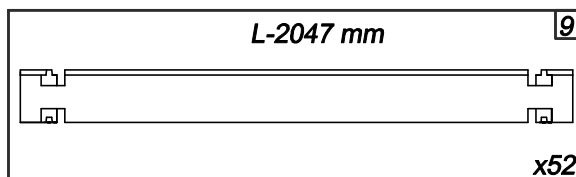
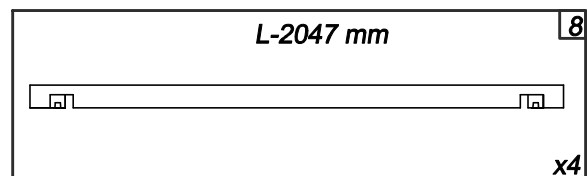
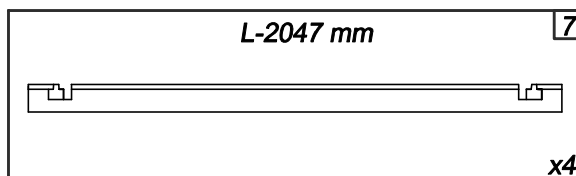
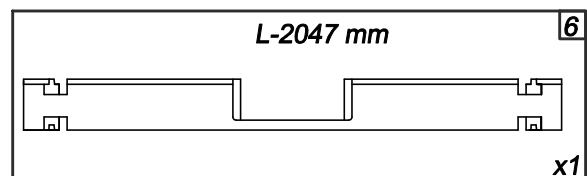
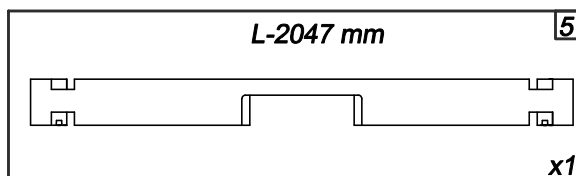
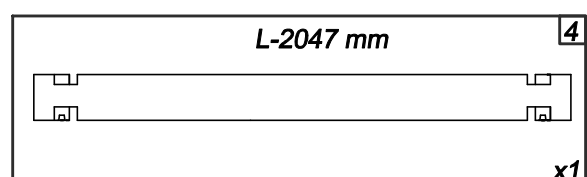
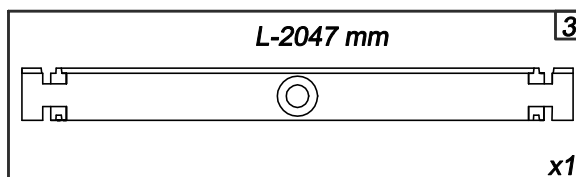
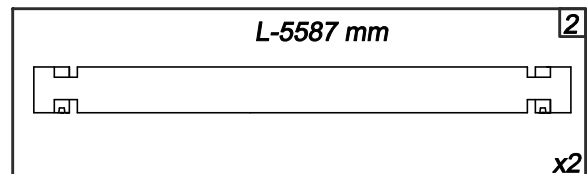
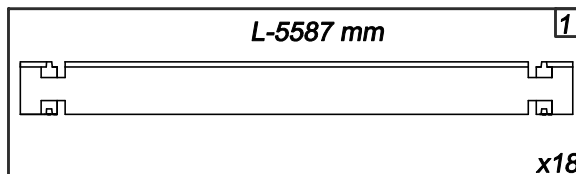
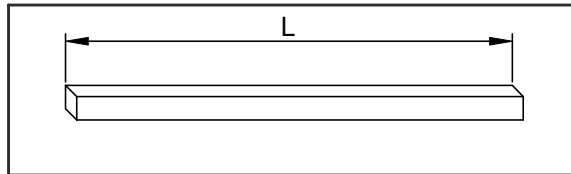

PL Elementy

GB Elements

D Elemente

FR Les éléments

IT Elementi

NL Balken



PL Sprawdź ilość oraz czy elementy nie są uszkodzone.

FR Vérifiez la quantité et si les éléments ne sont pas abîmés.

GB Check quantity of elements and if they are not faulty.

IT Controllare la quantità e se gli elementi non sono danneggiati.

D Sie die Menge, und ob die Elemente nicht beschädigt sind.

NL Controleer de aantal balken, en op eventuele beschadigingen.

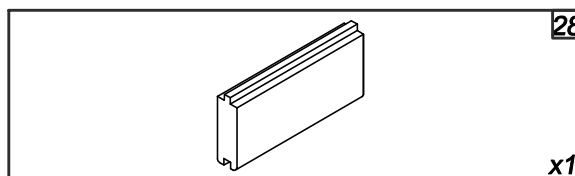
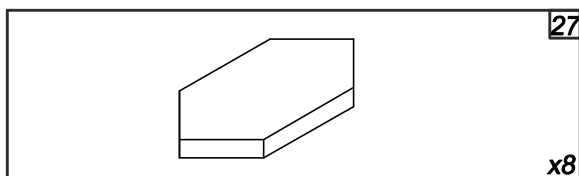
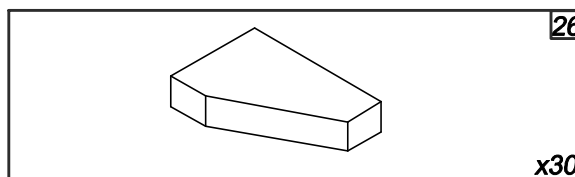
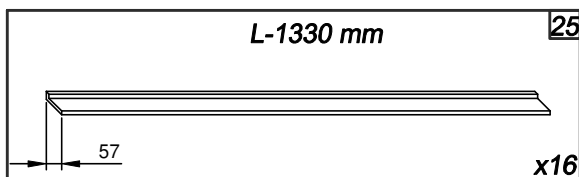
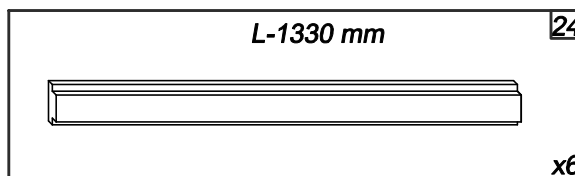
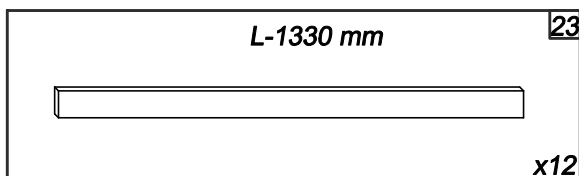
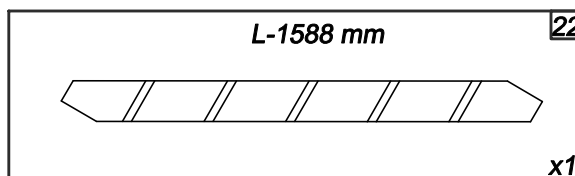
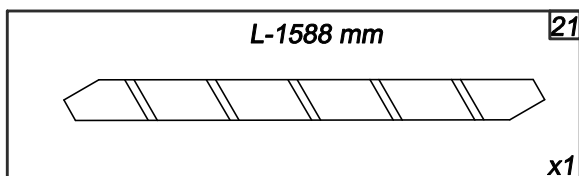
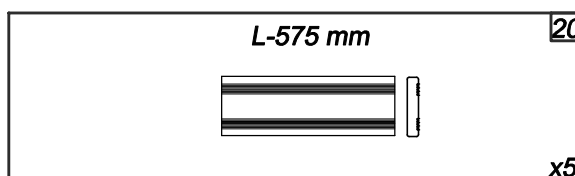
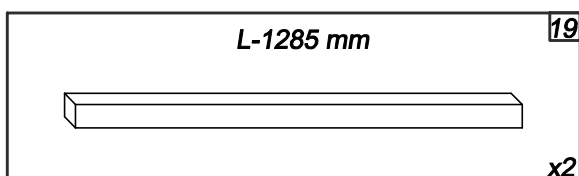
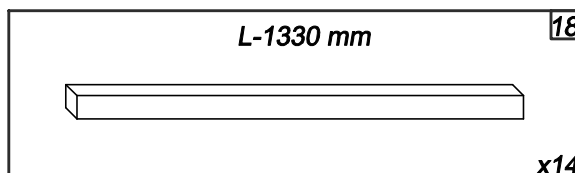
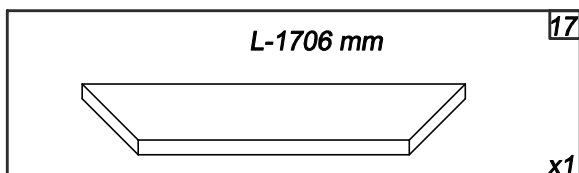

PL Okucia i sprzęt

GB Fittings and equipment

D Beschläge und Ausrüstung

FR Quincaillerie et l'équipement

IT Ferramenti e accessori

NL Bouwmaterialen



PL Sprawdź ilość.

FR Vérifiez la quantité.

GB Check quantity.

IT Controllare la quantità.

D Überprüfen Sie die Menge.

NL Controleer het aantal.

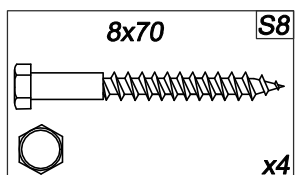
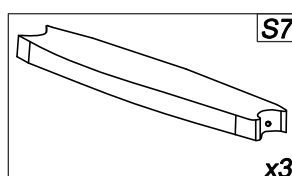
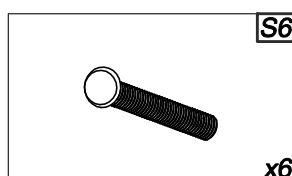
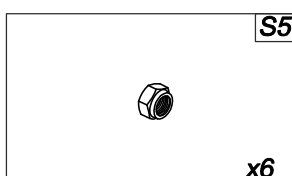
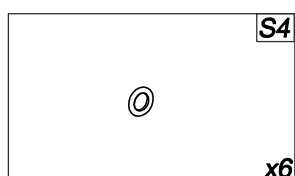
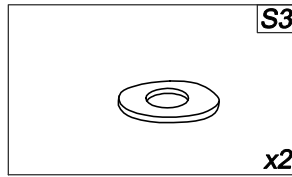
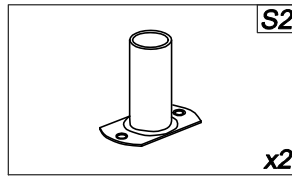
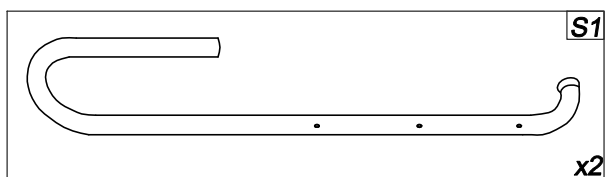
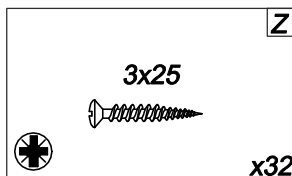
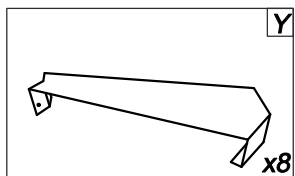
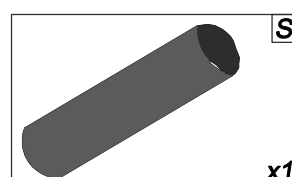
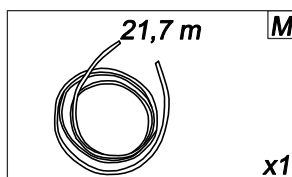
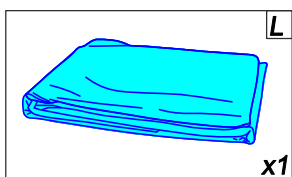
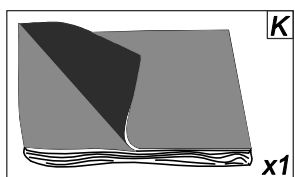
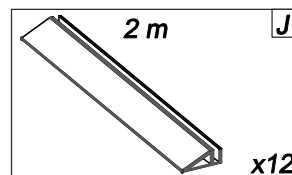
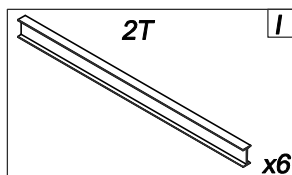
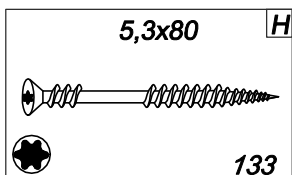
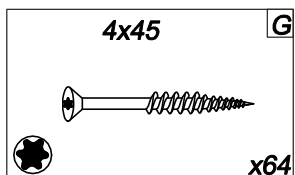
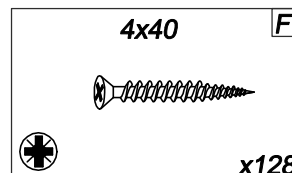
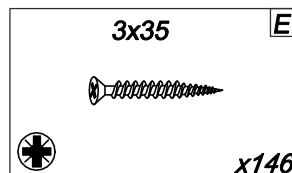
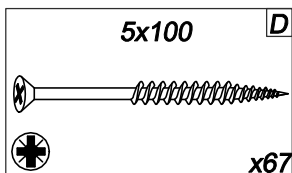
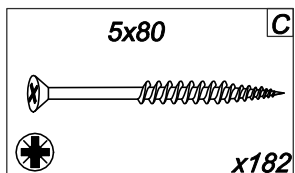
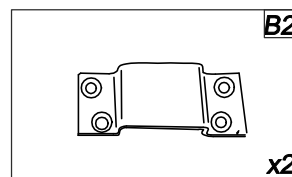
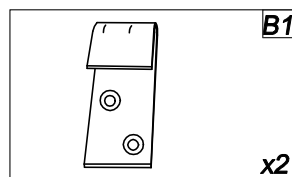
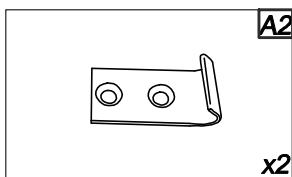
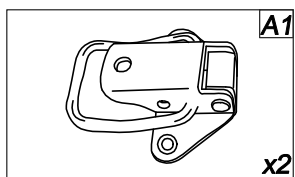

PL Skimmer i dysze

GB Skimmer and nozzles

D Skimmer und Düsen

FR Le skimmer et la buse de refoulement

IT Skimmer e ugelli

NL Skimmer en inlaat



PL Sprawdź ilość.

FR Vérifiez la quantité.

GB Check quantity.

IT Controllare la quantit.

D Überprüfen Sie die Menge.

NL Controleer het aantal.

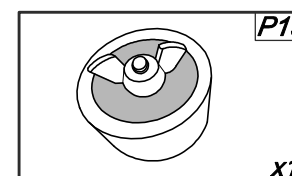
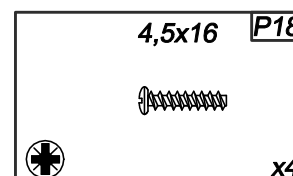
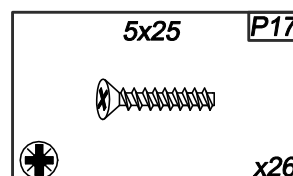
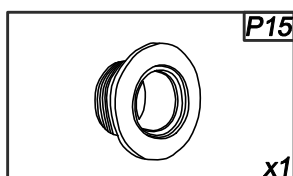
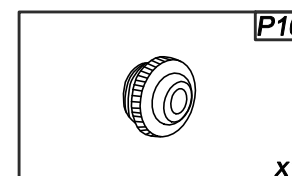
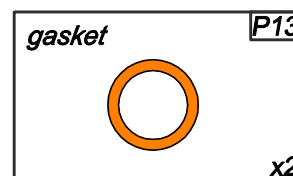
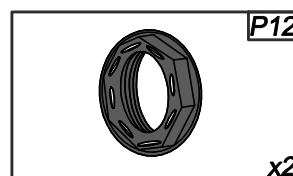
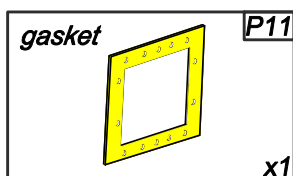
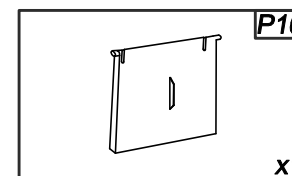
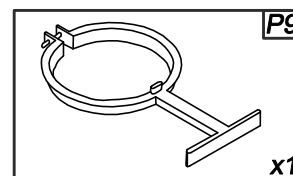
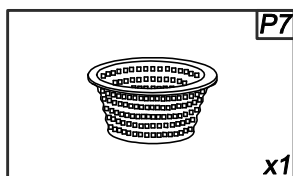
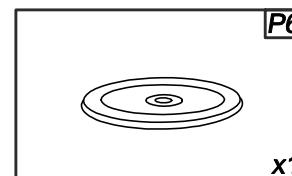
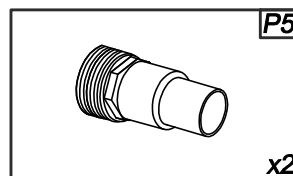
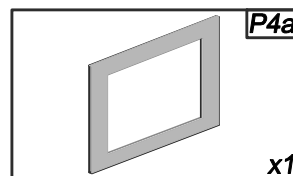
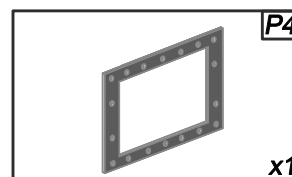
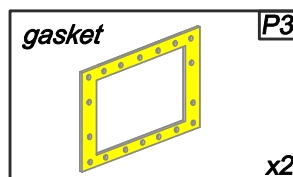
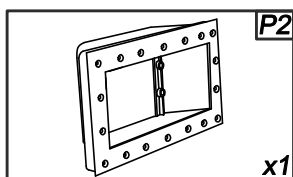
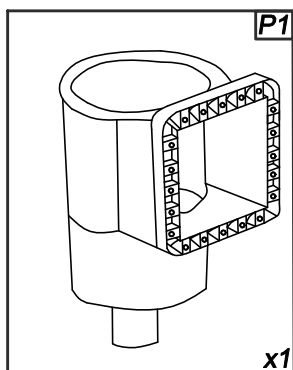

UWAGA / ATTENTION / NOTE / ATATTENZIONE / HINWEIS / LETOP

PL Poszczególne elementy osprzętu w instrukcji mogą się nieznacznie różnić od faktycznie dostarczonych.

FR Il est possible que certains éléments de l'équipement dans la notice de montage ne correspondront pas exactement f ceux fournis.

GB It is possible that some elements of equipment in the assembly instruction will not correspond exactly to those supplied

IT E possibile che degli elementi di attrezzatura nell'istruzione di riunione non corrisponderanno precisamente ad elementi approvvigionati.

D Es ist möglich, dass einige Elemente der Ausrüstung in der Versammlungsanweisung genau zu gelieferten Elementen nicht entsprechen werden.

NL Het is mogelijk dat sommige onderdelen in de montage-instructies niet exact overeenkomen

UWAGA / REMARQUE / NOTE / ATATTENZIONE / HINWEIS / LETOP

PL Widok po zmontowaniu.

FR La vue après le montage.

GB After installation.

IT Vista dopo il montaggio.

D Sicht nach der Montage

NL Na installatie

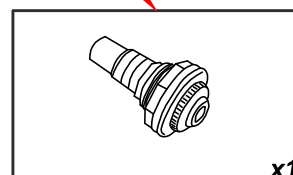
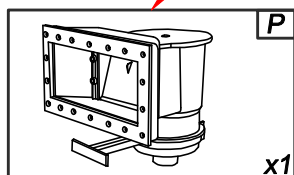

(PL) Opcja
(FR) Opzione

(GB) Option
(DE) Option

(NL) Optie



(PL) **Zatyczka do dyszy – w celu przygotowania basenu do sezonu zimowego (w szczególności przy ryzyku zamarznięcia wody), zastosuj zatyczkę do dysz napływowych, odcinając dopływ wody do zestawu filtracyjnego. Pozostaw dyszę w basenie, zamontuj zatyczkę pod wodą. Należy pamiętać również o odłączeniu zestawu filtracyjnego od źródła wody i dokładnym osuszeniu dyszy od strony zewnętrznej. Zaleca się także, aby z pompy jak i dołączonego filtra piaskowego na okres zimy (miejsca gdzie występują mrozy) usunąć pozostałości wody, w innym przypadku zamarzająca woda może dokonać zniszczenia całości zestawu.**

(FR) **Un bouchon pour la buse de refoulement - afin de préparer la piscine pour la saison d'hiver (en particulier dans le cas où il existe un risque de geler de l'eau), veuillez utiliser un bouchon fourni avec le skimmer qui fermera l'eau entre la piscine et le système de filtration. Veillez laisser la buse de refoulement dans la piscine, montez le bouchon sous l'eau. Il est également indispensable de débrancher le système de filtration et de l'écarter de la source d'eau, ainsi que de sécher consciencieusement la partie extérieure de la buse de refoulement. En plus, il est conseillé de vider le reste de l'eau se trouvant dans la pompe et le filtre à sable surtout pour la période des gels. L'eau qui gèle à l'intérieur du système de filtration peut causer des dégâts en le mettant en panne.**

(GB) **Rubber plug- in order to prepare a pool for a winter season (especially if there is a risk of freezing water) use a plug dedicated to inlet to shut the access of water to filtration system. Inlet must remain in a pool. Fix a plug under water. Remember to disconnect filtration set from source of water and dry the inlet (the part of inlet which is outside the pool). For winter season, it is recommended to get rid of water remaining in pump and sand filter, otherwise freezing water can cause devastation of whole set.**

(DE) **Stöpsel für die Düse - den Pool für die Wintersaison vorbereiten (insbesondere wegen der Gefahr des einfrierenden Wassers), verwenden Sie dazu die Zufusssdüse. Schneiden Sie die Wasserzufuhr zu dem Filtersystem ab, nachdem Sie den Filter abgetrennt haben, sollten Sie auf die gründliche Trocknung der Düse von außen achten, und dass die Filteranlage von der Wasserquelle abgetrennt ist. Lassen Sie die Düse in den Pool, installieren Sie den Stöpsel unter dem Wasser. Es wird auch empfohlen, aus dem Sandfilter sowie der Pumpe restliches Wasser zu entfernen (Stellen wo Frost entstehen kann), da sonst das gefrierende Wasser das komplette Filtersystem beschädigt.**

(NL) **Rubber plug - om het zwembad winterklaar te maken (zeker als er kans is op bevriezing) dient u de plug in de inspuiter te plaatsen om zo de watertoevoer naar het filtersysteem af te sluiten. De inspuiter moet in het zwembad blijven; de plug komt onder water. Denk er aan de filterset los te koppelen van het bad en maak de inspuiter droog (het gedeelte aan de buitenkant van het bad). Gedurende het winterseizoen wordt aanbevolen het restwater uit de pomp en de zandfilter te verwijderen om kapotvriezen van de complete installatie te voorkomen.**

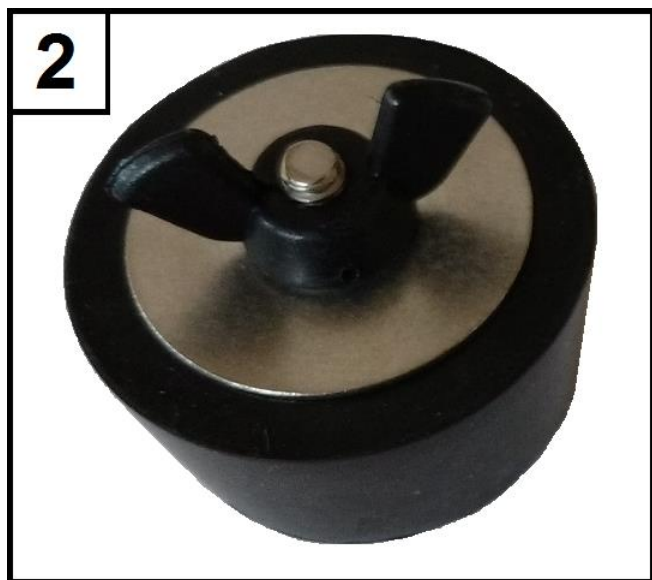
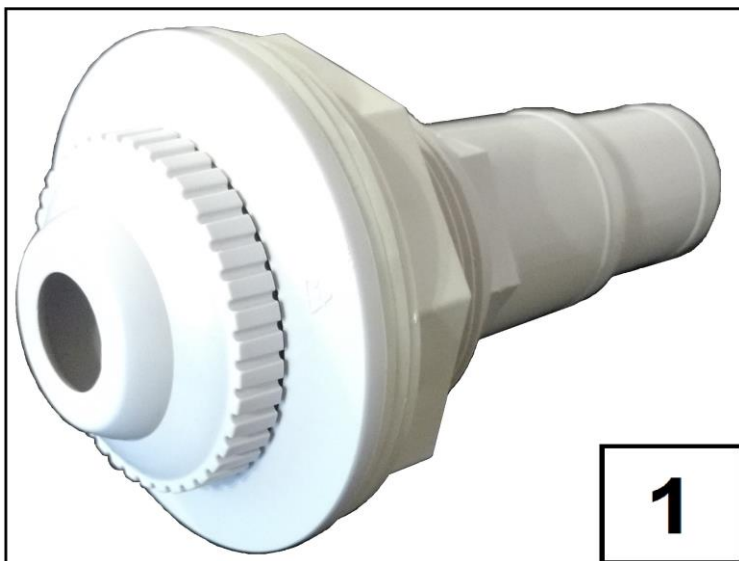

PL Narzędzia

GB Tools

D Werkzeuge

FR Les outils

IT Strumenti

NL Gereedschap

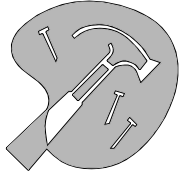

PL Przygotuj niezbędne narzędzia - niezawarte w zestawie.

FR Préparez les outils nécessaires - pas inclus.

GB Prepare essential tools- not included.

IT Preparare gli strumenti necessari - non inclusi nel set.

D Bereiten Sie notwendiges, nicht im Satz enthaltenes Werkzeug vor.

NL Benodigd gereedschap - niet inbegrepen.

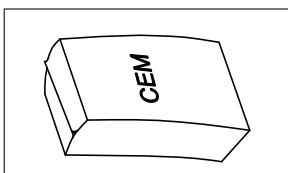
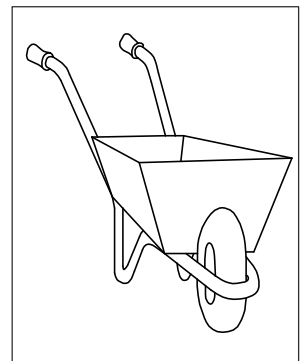
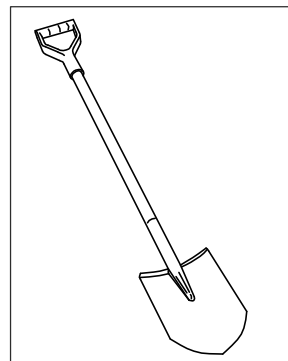
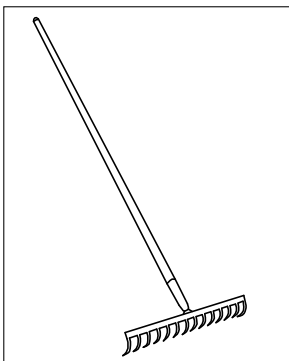
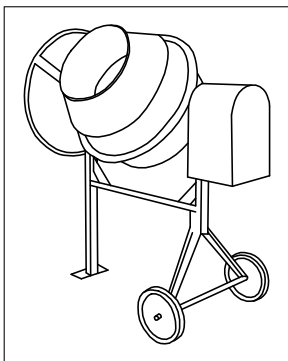
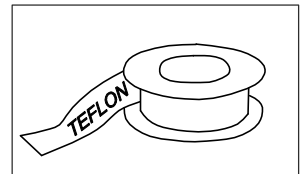
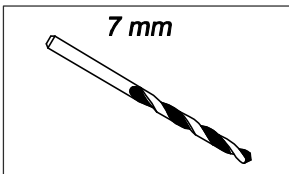
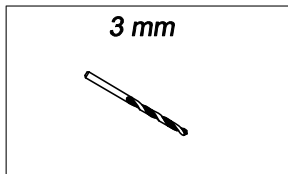
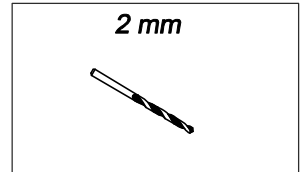
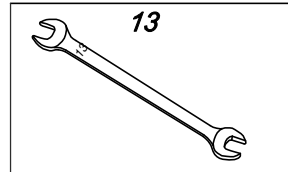
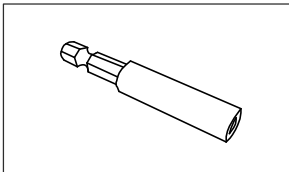
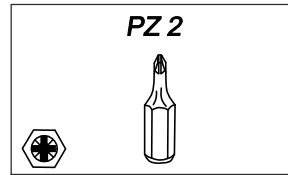
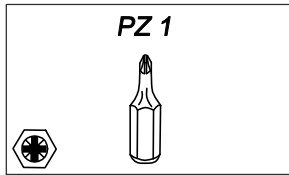
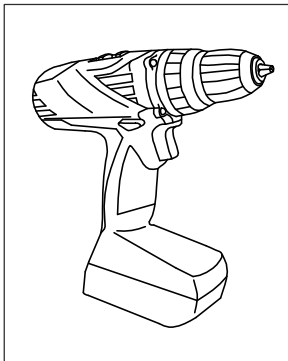
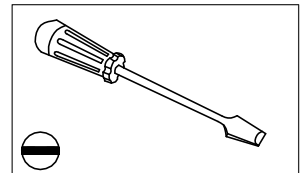
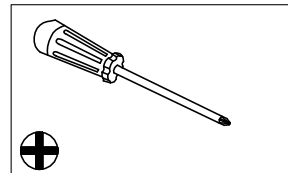
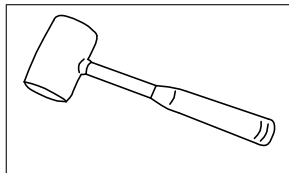
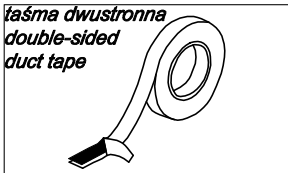
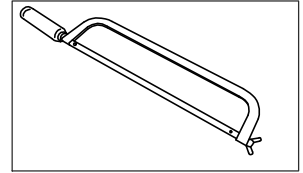
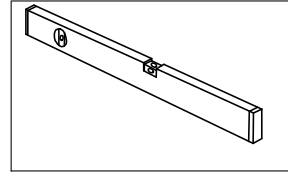
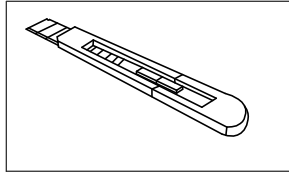
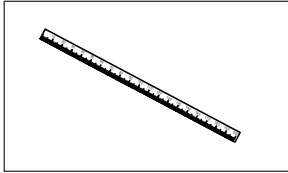
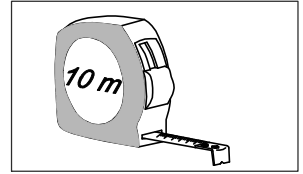
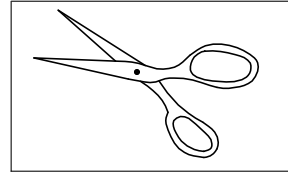
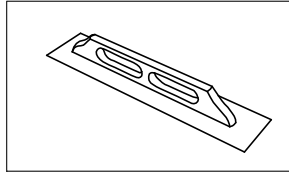
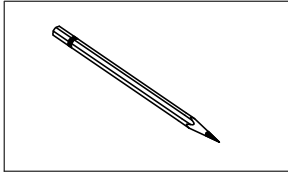

(PL) Podłoże

(GB) Ground

(D) Untergrund

(FR) Terrain

(IT) Suolo

(NL) Ondergrond



- (PL)** Struktura basenu wkopanego musi być zabezpieczona zgodnie z dołączoną dodatkowo dokumentacją.
(FR) Il est exigé que la structure de la piscine enterrée soit convenablement protégée selon les indices dans le document supplémentaire ci-joint.
(GB) Structure of in-ground pool must be secured in accordance with additional enclosed documentation.
(IT) È esatto che la struttura della piscina seppellita sia protetta correttamente in allegato secondo gli indizi nel documento supplementare.
(D) Die Struktur des Pools, der ausgegraben wird, muss gesichert werden, gemäß information in der Begleitdokumentation.
(NL) De constructie van het ingebouwde zwembad moet beschermd worden volgens de instructies in bijgaande documentatie.

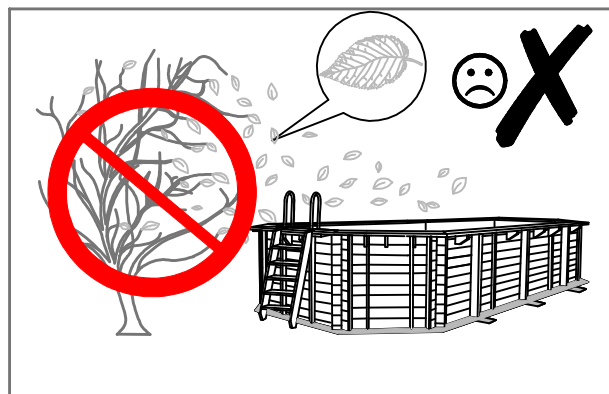
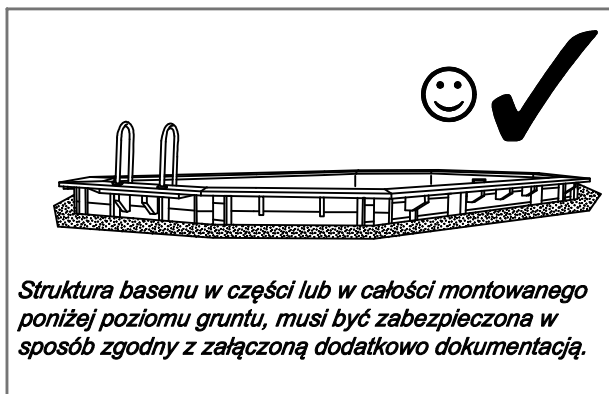
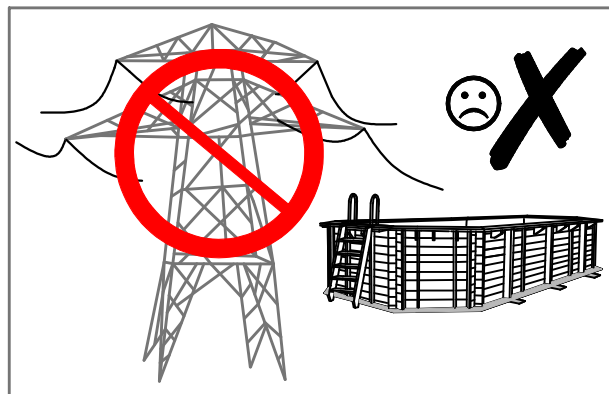
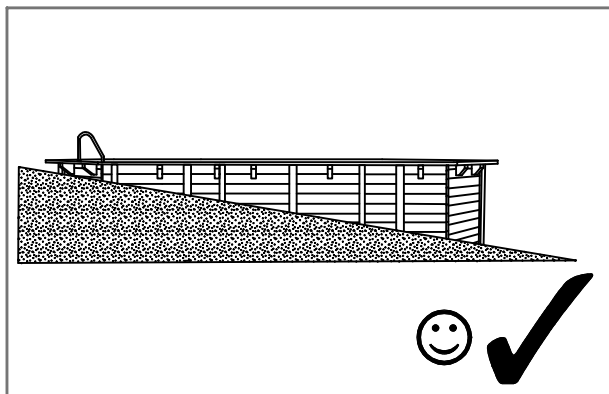
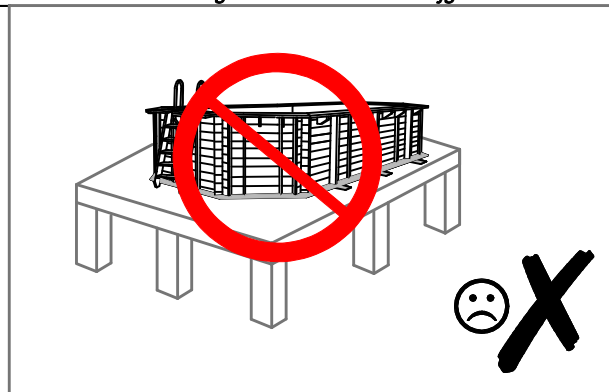
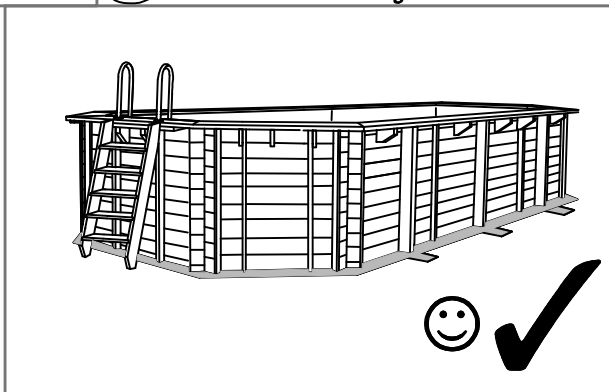

(PL) Struktura basenu w części lub w całości montowanego poniżej poziomu gruntu, musi być zabezpieczona w sposób zgodny z załączoną dodatkowo dokumentacją.

Il est exigé que la structure de la piscine enterrée ou

(FR) *semi-enterrée soit convenablement protégée selon les indices dans le document supplémentaire ci-joint.*

(GB) *Structure of partly or fully in-ground pool, must be secured in accordance with additional enclosed documentation.*

(IT) *È esatto che la struttura della piscina sepolta o semi-sepolta sia protetta correttamente in allegato secondo gli indizi nel documento supplementare.*

(D) *Die Struktur des Pools, die teilweise oder vollständig unter der Erdoberfläche montiert ist, muss gemäß der beiliegenden Dokumentation gesichert werden.*

(NL) *De constructie van het half- of volledig ingebouwde zwembad moet beschermd worden volgens de instructies in bijgaande documentatie.*

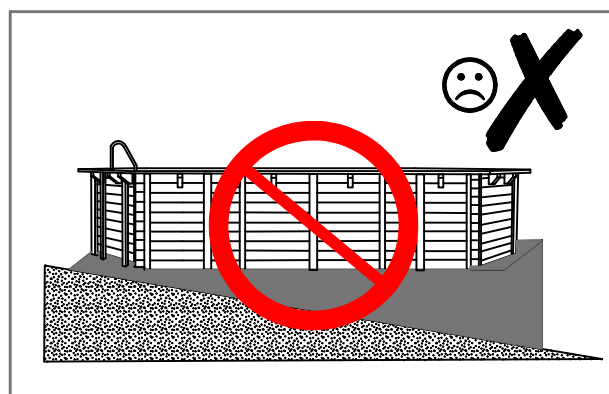

(PL) Podłoże

(GB) Ground

(DE) Untergrund

(FR) Terrain

(IT) Suolo

(NL) Ondergrond



- (PL)** Wymagane zabezpieczenie struktury przy montażu basenu poniżej poziomu gruntu.
(FR) La protection de la structure dans le cas de la piscine totalement ou partiellement enterrée.
(GB) Wooden structure protection required in case of in-ground installation.
(IT) La protezione della struttura nel caso della piscina totalmente o parzialmente sepolta.
(DE) Erforderliches Schutz für Struktur eines Holzpool, wenn es unter der Boden montieren.
(NL) Bescherming van de houten constructie is absoluut noodzakelijk bij ingebouwde zwembaden.

- 1** FUNDAMENT BASENU / DALLE BETON / FOUNDATION / LASTRA CEMENTO / DAS FUNDAMENT / FUNDERING
- 2** RURA DRENARSKA / TUYAU DE DRAINAGE / DRAINAGE PIPE / TUBO DI DRENAGGIO / DIE DRAINAGEROH / AFVOERPIJP
- 3** PEÇHERZYKOWA FOLIA FUNDAMENTOWA / PROTECTION DE SOUBASSEMENT / FOINDATION BUBBLE WRAP / FONDALINE / DAS FUNDAMENT NOPPENFOLIE / BOUWFOLIE
- 4** ŻWIR / GRAVIER / GRAVEL / GHIAIA / DER KIES / GRAVEL
- 5** GEOWŁÓKNINA OGRODOWA / GEOTEXTILE / GEOTEXTILE / GEOTESSILI / GARTEN GEOTEXTILE / GEOTEXTEL
- 6** GRUNT / TERRAIN / GROUND / TERRENO / DER BODEN / BODEM

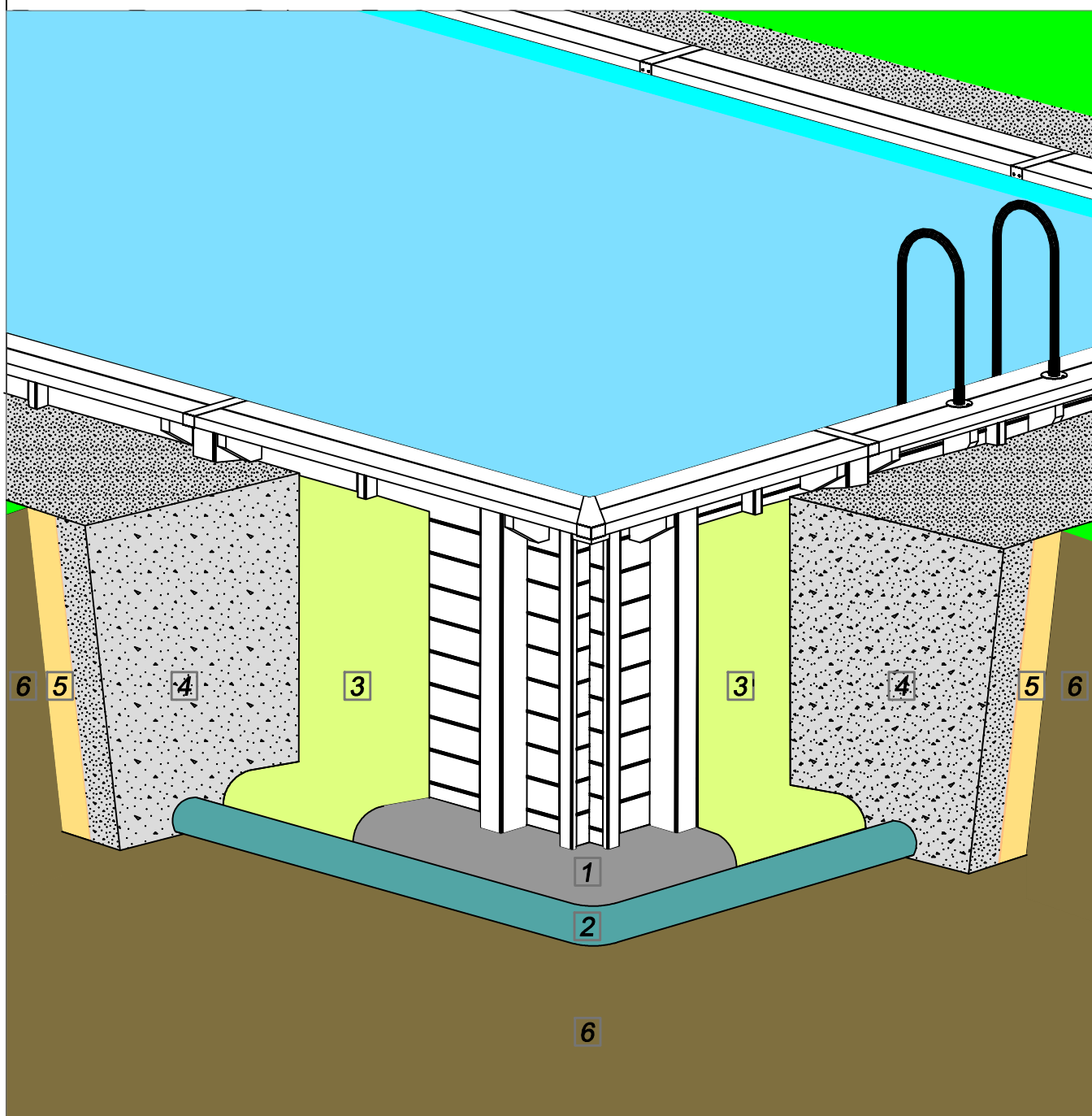

(PL) Podłóże

(GB) Ground

(D) Untergrund

(FR) Terrain

(IT) Suolo

(NL) Ondergrond



(PL) Schemat rozmieszczenia słupków 2T (I) oraz przygotowania wylewki betonowej.

(FR) Le schéma de la disposition des poteaux métalliques 2T (I) et de la préparation de la dalle en béton.

(GB) Scheme of steel bearers 2T (I) arrangement, preparing concrete base.

(IT) Schematica dei pilastri 2T (I) e della preparazione di calcestruzzo.

(D) Schematische Darstellung von 2T - Säulen (I) und Vorbereitung des Betonestriches.

(NL) Installatie van de stalen dragers 2T (I) met betonnen voet.

[mm]

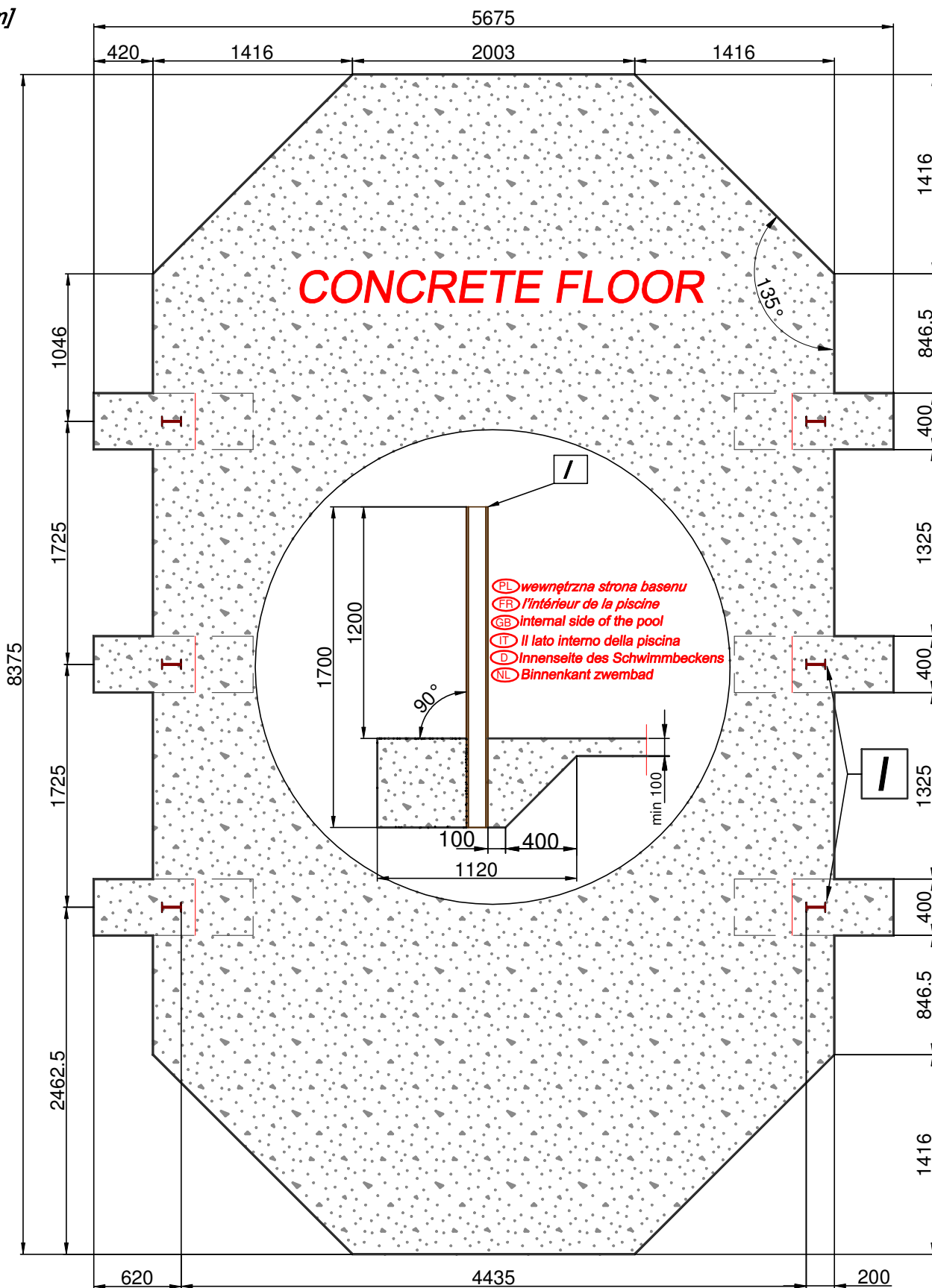

PL Podłoże

GB Ground

D Untergrund

FR Terrain

IT Suolo

NL Ondergrond



PL Powierzchnia musi być twarda, płaska i wypoziomowana. Zastosuj cement fundamentowy.

FR Le terrain doit être rigoureusement plat, dur et de niveau. Utilisez le ciment de soubassement.

GB The surface must be firm, flat and leveled. Use cement for foundations.

IT La superficie deve essere solida, piana e livellata. Applicare il cemento per i fondamenti.

D Der Untergrund muss fest, flach und eben sein. Verwenden Sie das Zementfundament.

NL De ondergrond moet stevig, vlak en genivelleerd zijn. Gebruik cement voor de fundering.

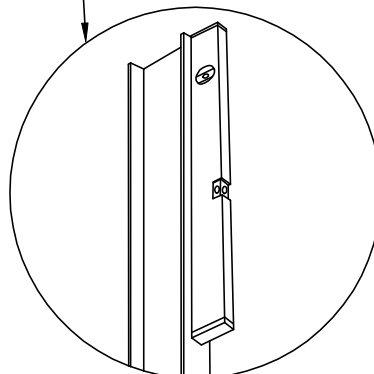
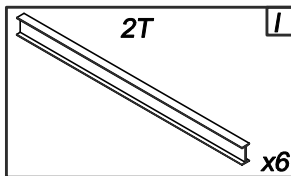
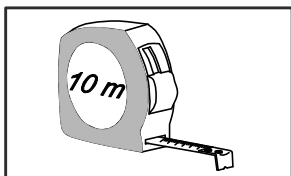
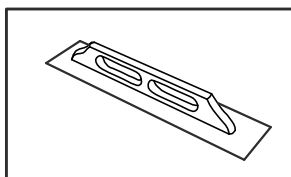
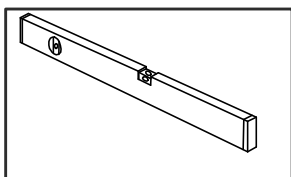
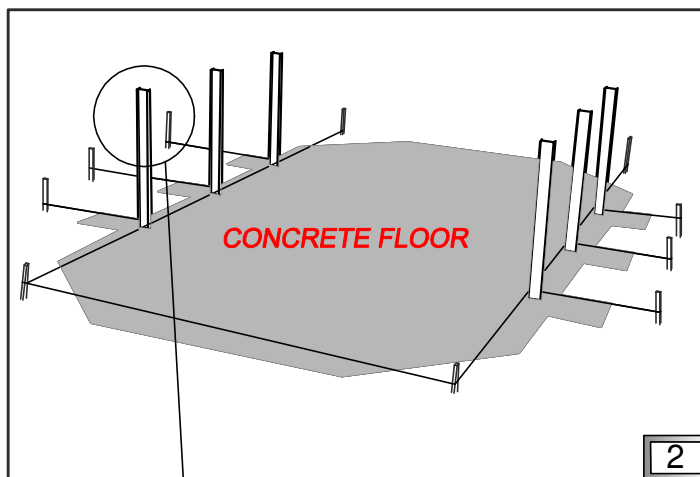
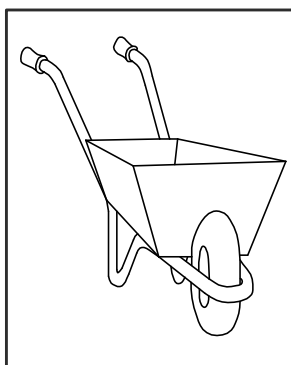
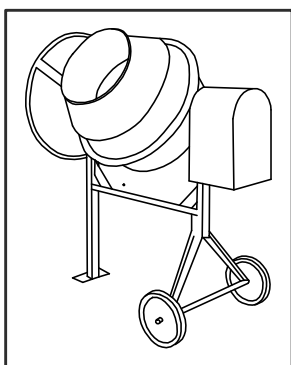
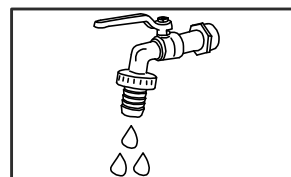
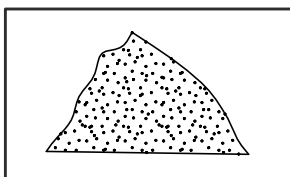
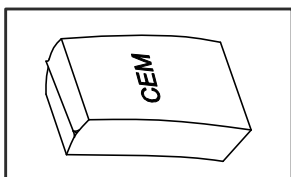
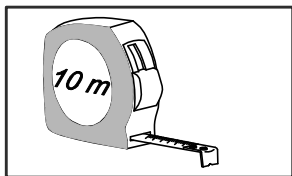
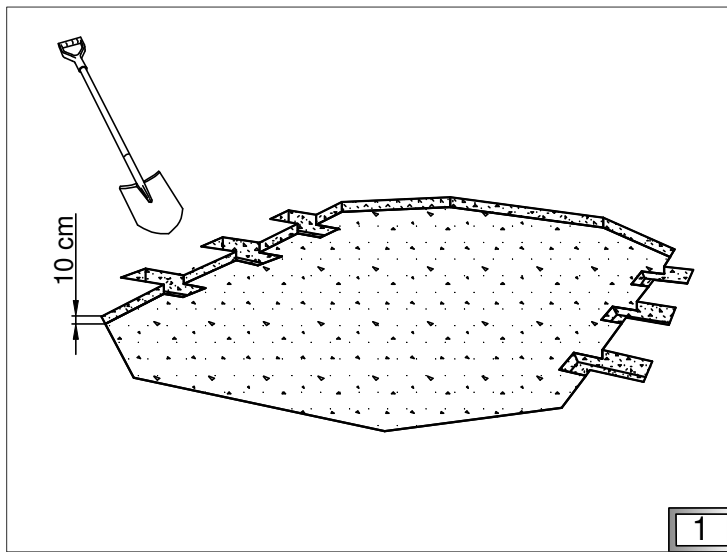
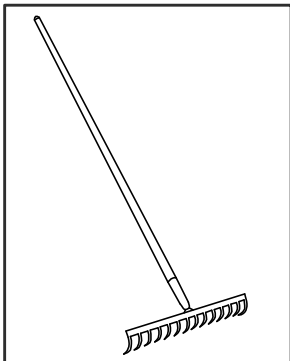
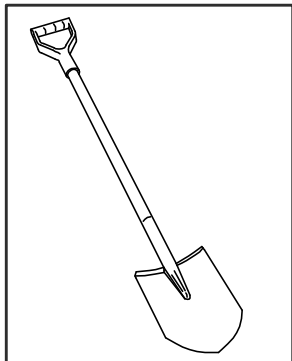

(PL) *Struktura drewniana*

(GB) *Wooden structure*

(D) *Holzstruktur*

(FR) *La structure bois*

(IT) *Struttura in legno*

(NL) *Houten structuur*



(PL) *Schemat rozmieszczenia warstw struktury. Ułożenie warstwy I.*

(FR) *Le schéma de la disposition des couches de la structure. La pose de la couche I.*

(GB) *Arrangement of structure's layers. Putting layer I.*

(IT) *Schematica degli strati della struttura. Posare lo strato I.*

(D) *Schema der Anordnung von Strukturschichten. Auflegen der I-Schichte.*

(NL) *Begin met laag I van het houten structuur, zie overzicht.*

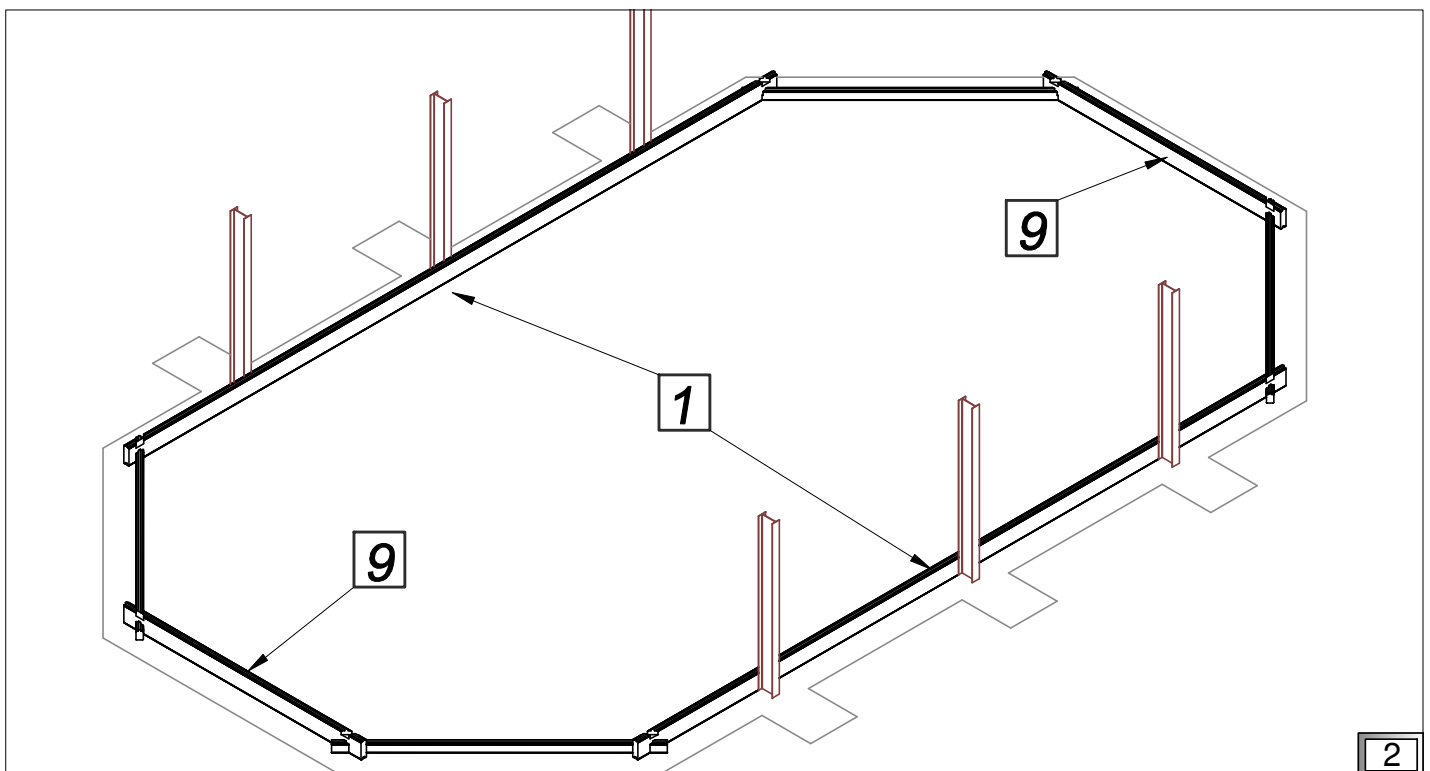
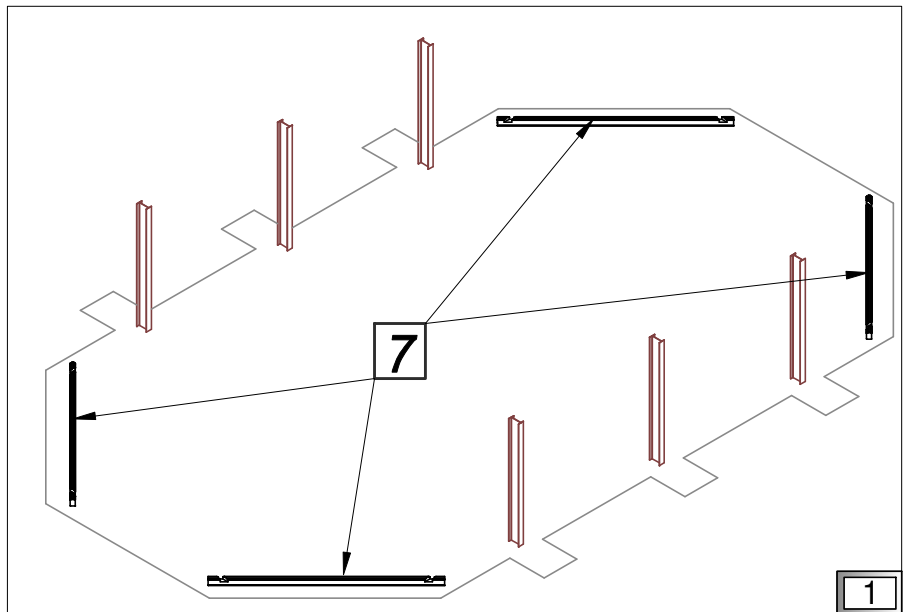
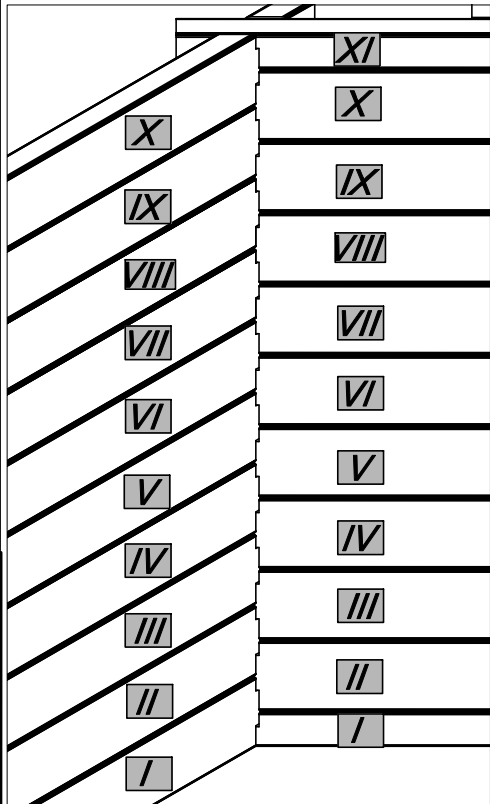
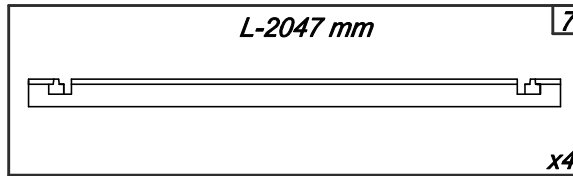
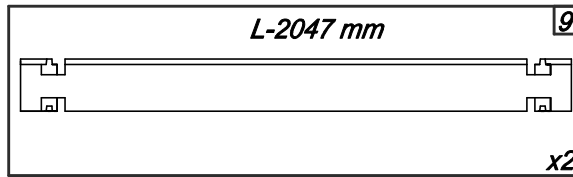
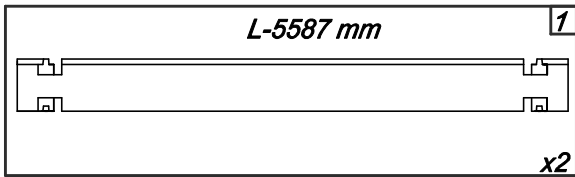

(PL) *Struktura drewniana*

(GB) *Wooden structure*

(D) *Holzstruktur*

(FR) *La structure bois*

(IT) *Struttura in legno*

(NL) *Houten structuur*



(PL) *Po ułożeniu każdej z warstw sprawdź przekątne D według rysunku.*

(FR) *Vérifiez les diagonales "D" après la pose de chaque tour.*

(GB) *After putting each layer check D diagonals according to the drawing.*

(IT) *Dopo la posa di ogni strato bisogna controllare diagonali D, secondo il disegno.*

(D) *Nach Verlegen von jeder Schicht kontrollieren Sie D-Diagonale nach Schema.*

(NL) *Na het bouwen van de eerste laag controleer D diagonalen volgens de tekening.*

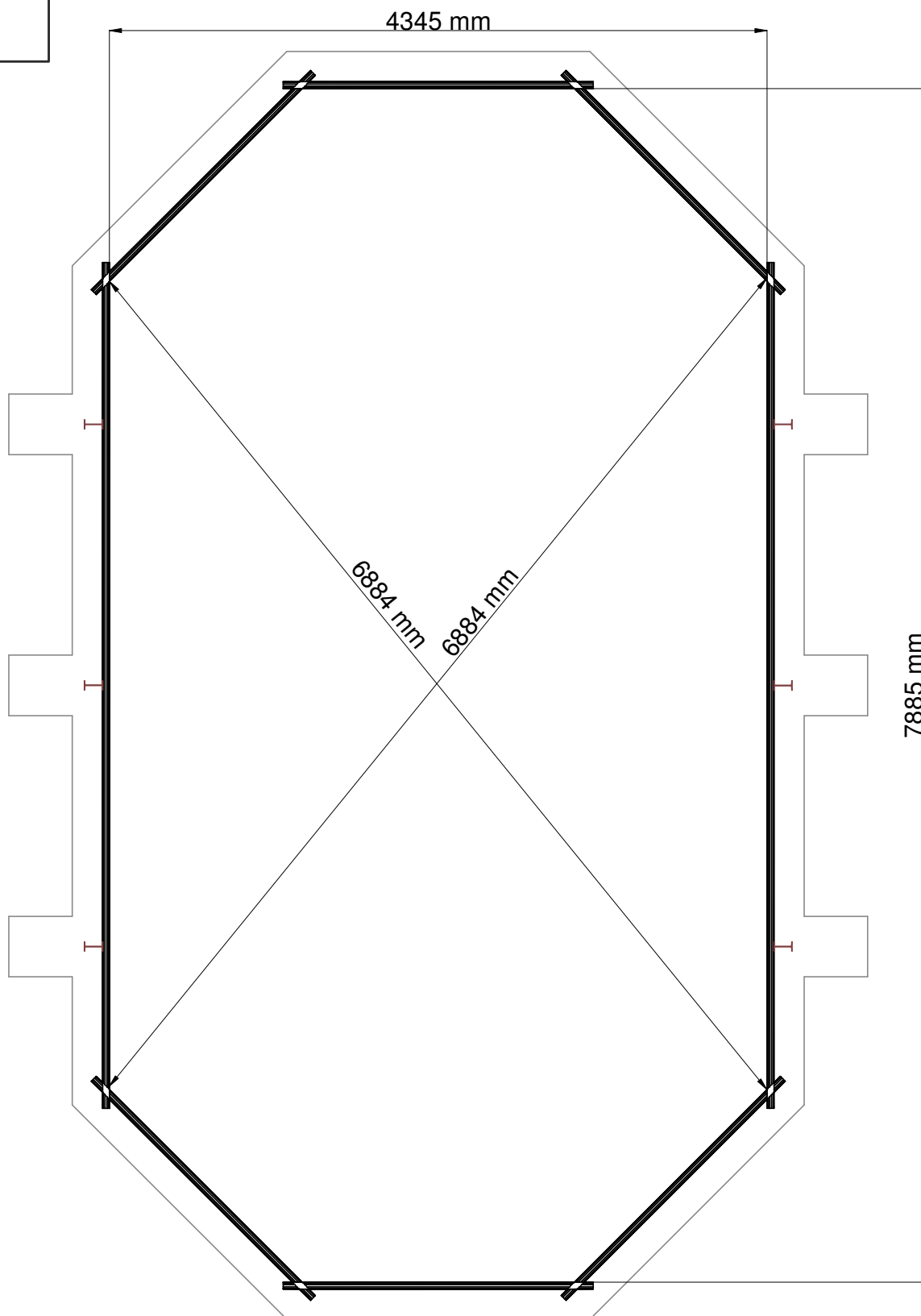
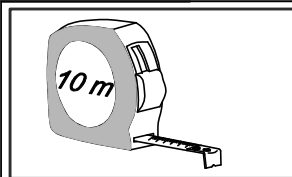

(PL) Struktura drewniana

(GB) Wooden structure

(D) Holzstruktur

(FR) La structure bois

(IT) Struttura in legno

(NL) Houten structuur



(PL) Ułożenie kolejnych warstw. Sprawdzaj przekątną D po każdej ułożonej warstwie.

(FR) L'assemblage des couches suivantes. Vérifiez les diagonales "D" après la pose de chaque tour.

(GB) Putting next layers. Check D diagonals every layer.

(IT) La messa degli strati successivi. Trova la diagonale D dopo ogni strato.

(D) Verlegen der nachfolgenden Schichten. Nach Verlegen von jeder Schicht kontrollieren Sie die D-Diagonale.

(NL) Installeer de volgende lagen en controleer diagonaal D.

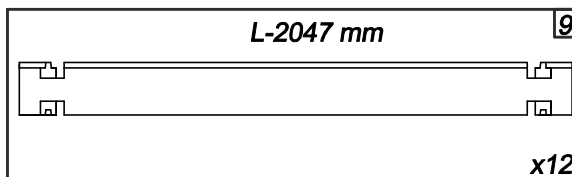
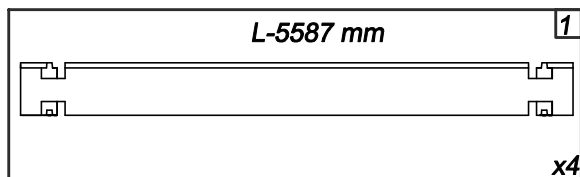

II-III

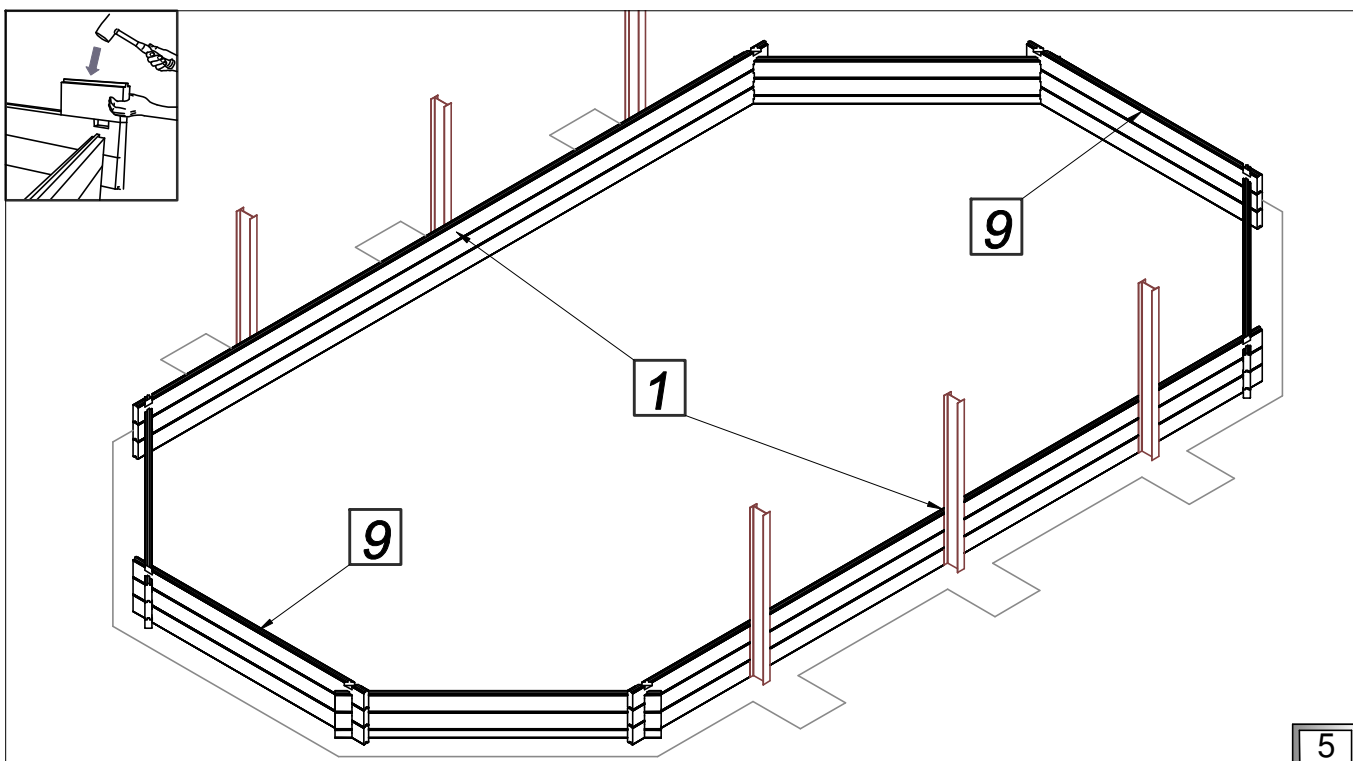
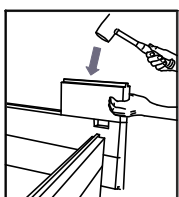
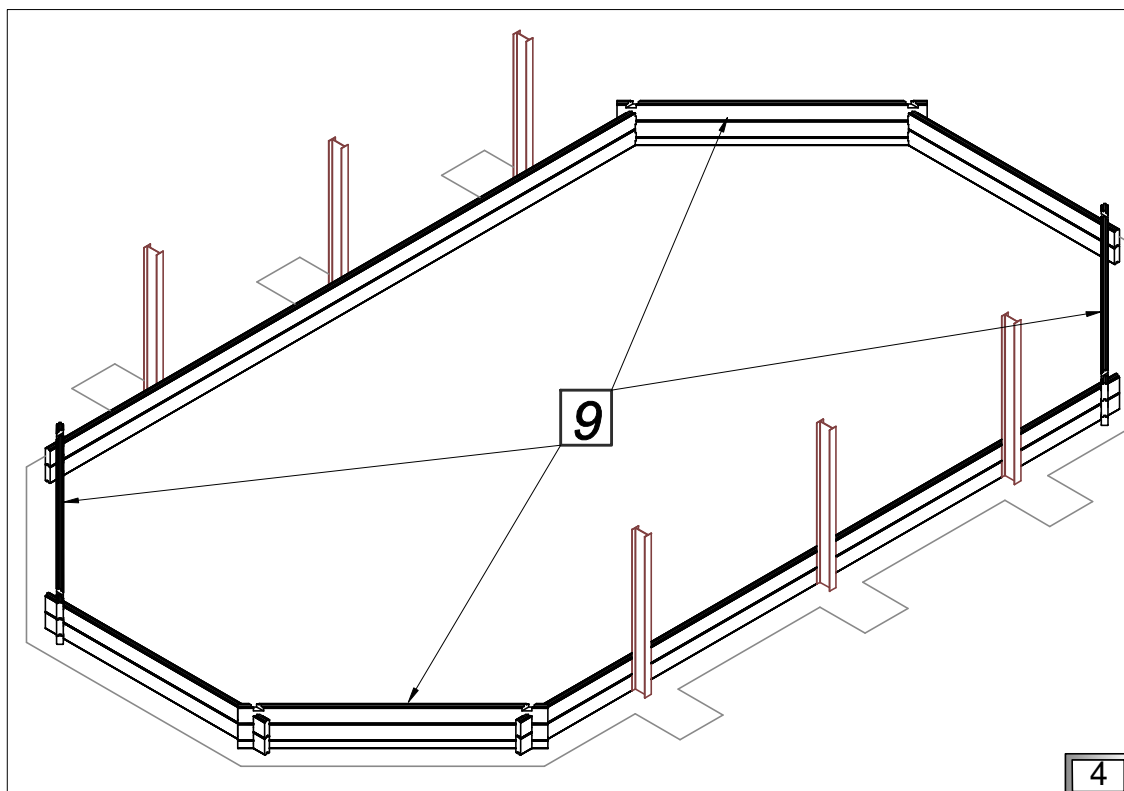
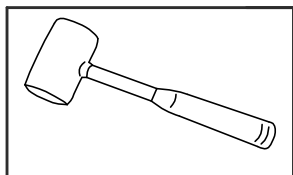
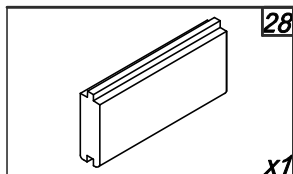

(PL) Struktura drewniana

(GB) Wooden structure

(D) Holzstruktur

(FR) La structure bois

(IT) Struttura in legno

(NL) Houten structuur



(PL) Ułożenie kolejnych warstw. Sprawdzaj przekątną D po każdej ułożonej warstwie.

(FR) L'assemblage des couches suivantes. Vérifiez les diagonales "D" après la pose de chaque tour.

(GB) Putting next layers. Check D diagonals every layer.

(IT) La messa degli strati successivi. Trova la diagonale D dopo ogni strato.

(D) Verlegen der nachfolgenden Schichten. Nach Verlegen von jeder Schicht kontrollieren Sie die D-Diagonale.

(NL) Installeer de volgende lagen en controleer diagonaal D.

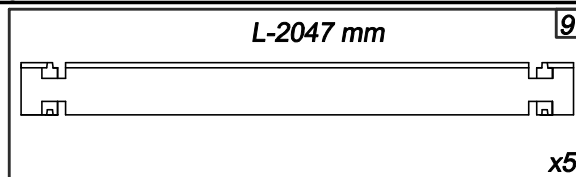
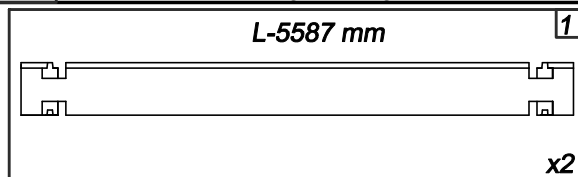

IV

(NL) Installeer balk nummer 3 alleen op laag 4 in gebieden waar de temperatuur niet onder nul komt, is dit wel het geval plaats dan balk nummer 3 drie lagen hoger (risico op bevriezing)

(D) Installieren Sie die Nr. 3 auf der Schicht 4, wo fällt die Temperatur unten 0 ° C. Anderenfalls Teil Nr. 3 installieren Schicht oben. (Risiko ganz gefroren.)

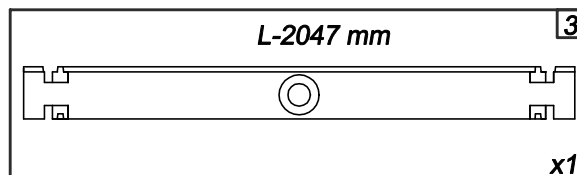

(GB) Install the beam no 3 on the 4th layer. If pool installed in area where temperatures fall below 0°C, install the beam no 3 on higher layer.

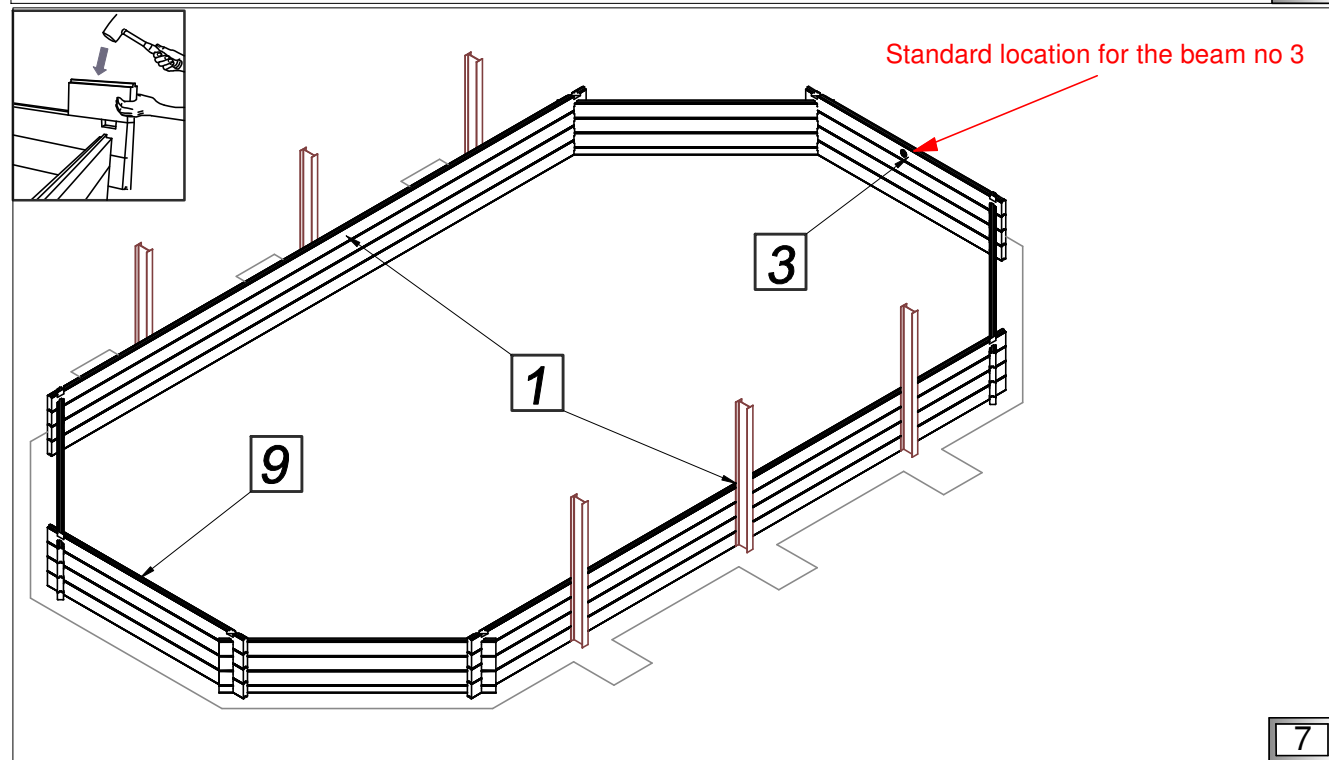
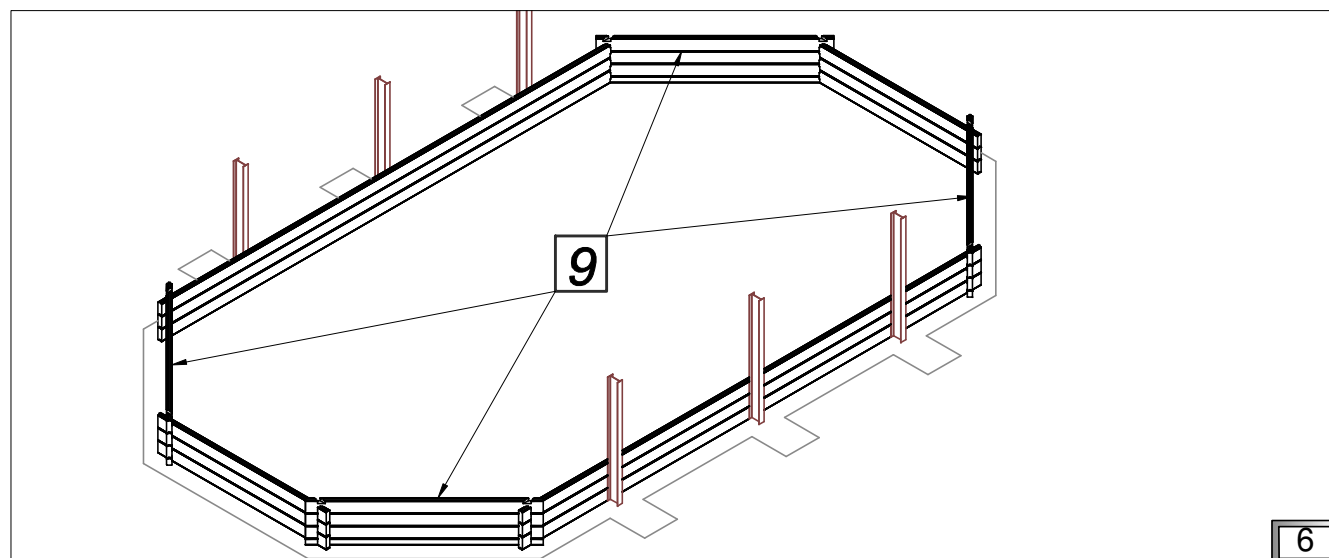

PL Struktura drewniana

GB Wooden structure

D Holzstruktur

FR La structure bois

IT Struttura in legno

NL Houten structuur



PL Ułożenie kolejnych warstw. Sprawdzaj przekątną D po każdej ułożonej warstwie.

FR L'assemblage des couches suivantes. Vérifiez les diagonales "D" après la pose de chaque tour.

GB Putting next layers. Check D diagonals every layer.

IT La messa degli strati successivi. Trova la diagonale D dopo ogni strato.

D Verlegen der nachfolgenden Schichten. Nach Verlegen von jeder Schicht kontrollieren Sie die D-Diagonale.

NL Installeer de volgende lagen en controleer diagonaal D.

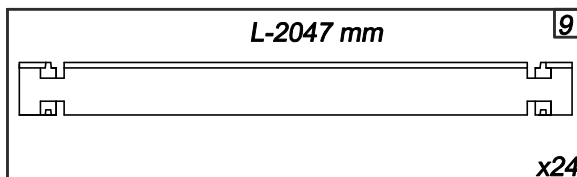
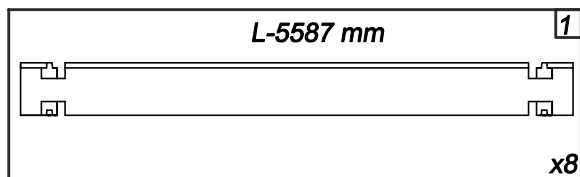

V-VIII

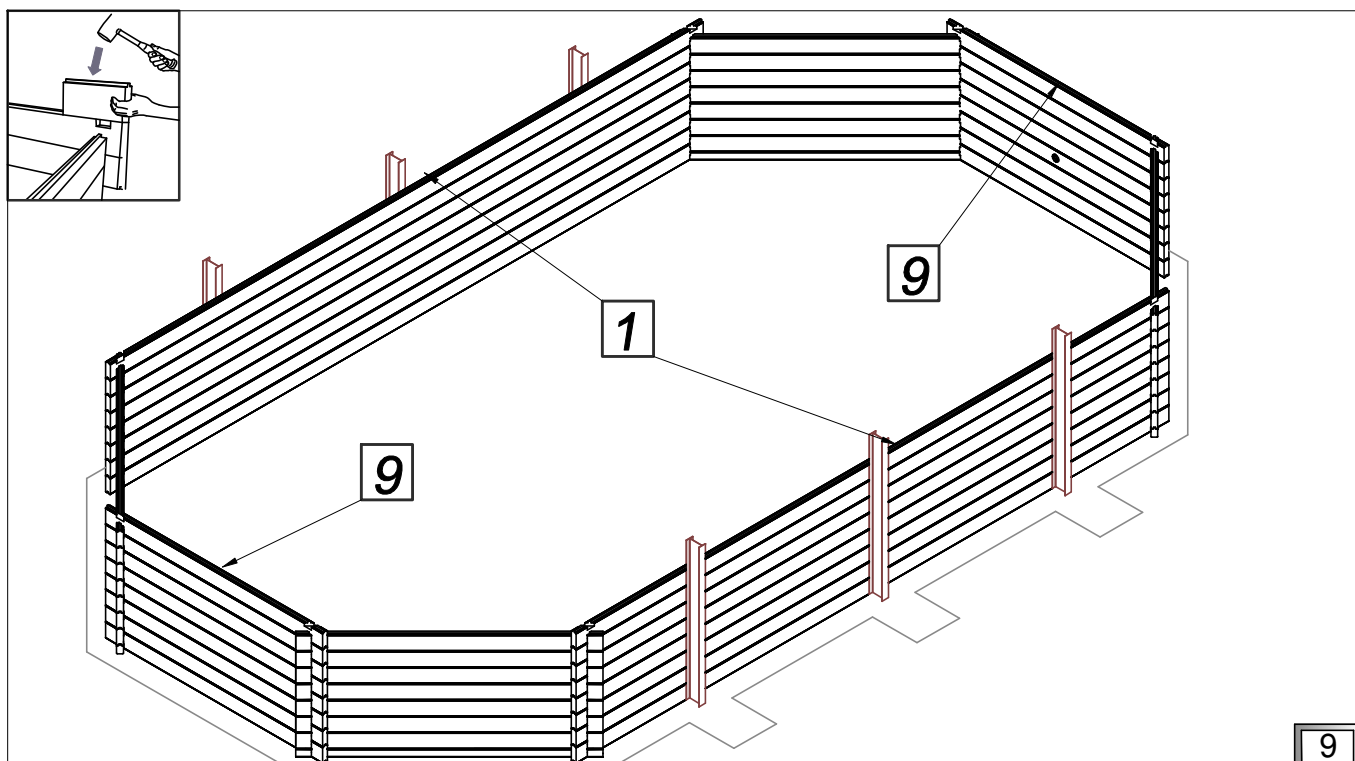
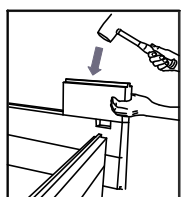
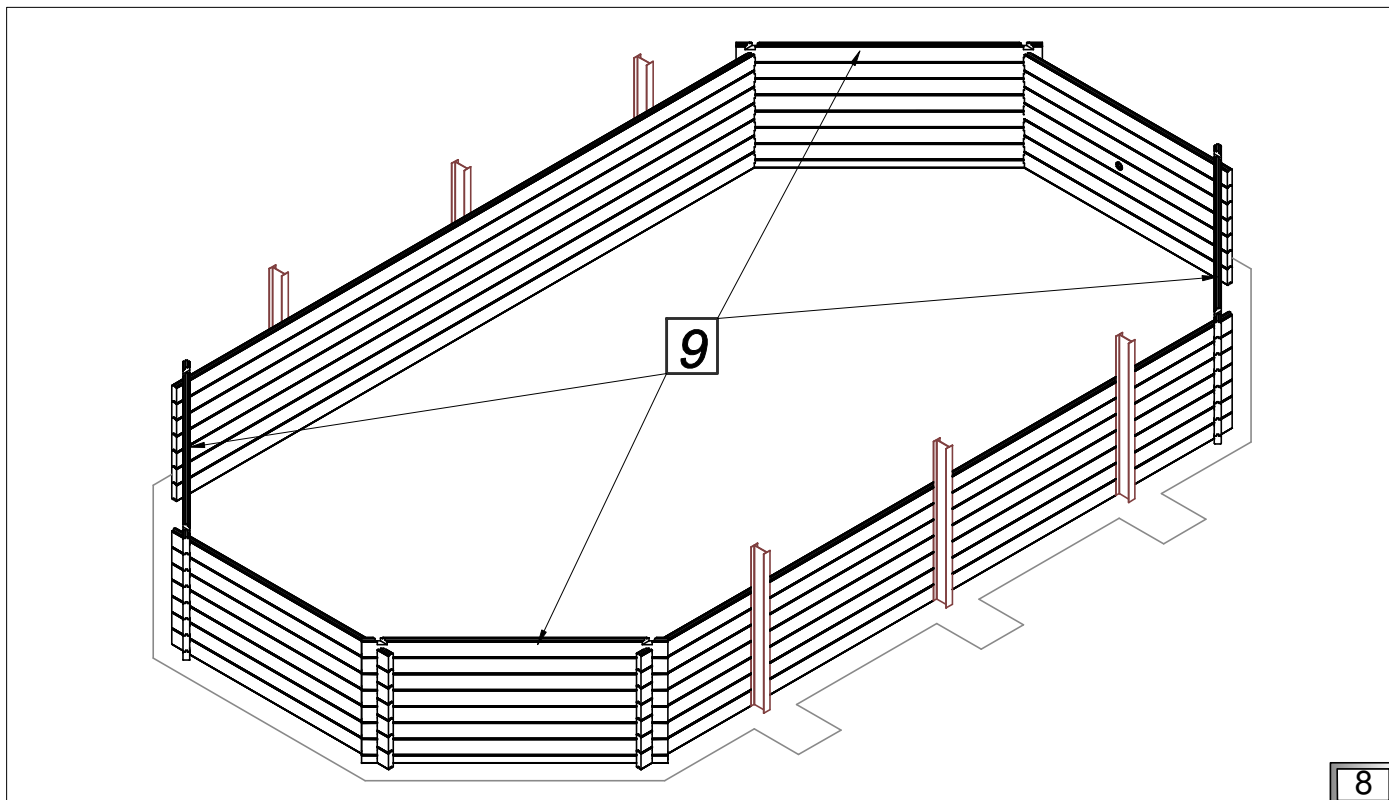

(PL) Struktura drewniana

(GB) Wooden structure

(D) Holzstruktur

(FR) La structure bois

(IT) Struttura in legno

(NL) Houten structuur



(PL) Ułożenie kolejnych warstw. Sprawdzaj przekątną D po każdej ułożonej warstwie.

(FR) L'assemblage des couches suivantes. Vérifiez les diagonales "D" après la pose de chaque tour.

(GB) Putting next layers. Check D diagonals every layer.

(IT) La messa degli strati successivi. Trova la diagonale D dopo ogni strato.

(D) Verlegen der nachfolgenden Schichten. Nach Verlegen von jeder Schicht kontrollieren Sie die D-Diagonale.

(NL) Installeer de volgende lagen en controleer diagonaal D.

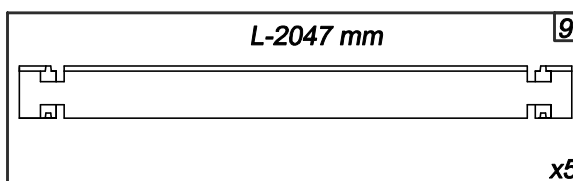
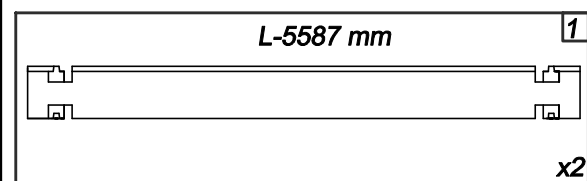

IX

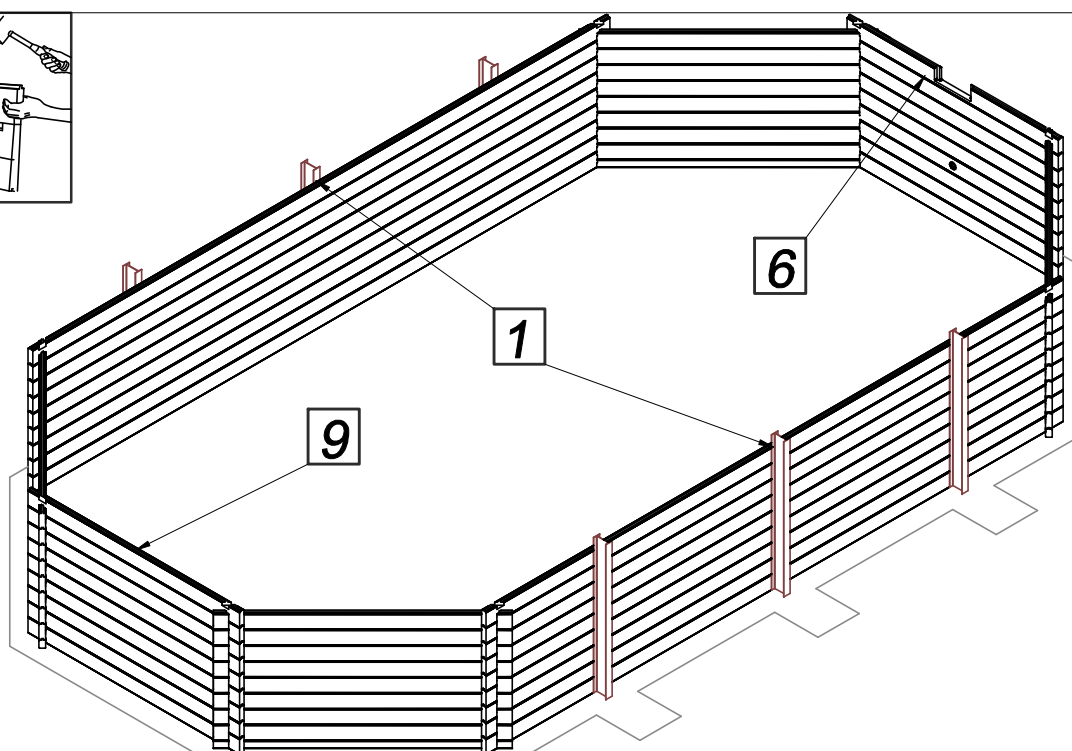
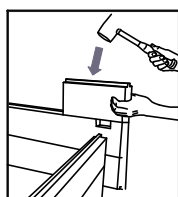
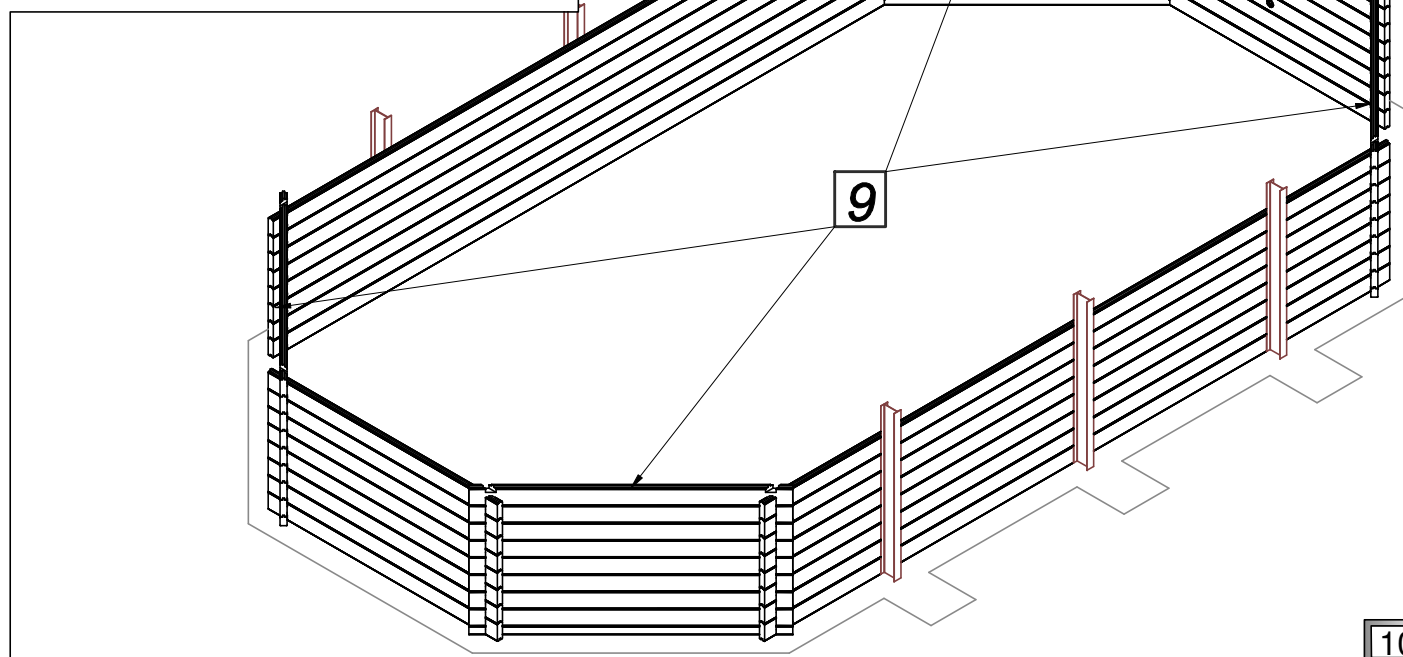
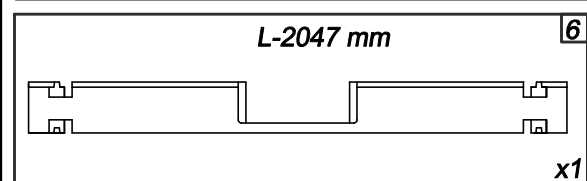

(PL) Struktura drewniana

(GB) Wooden structure

(D) Holzstruktur

(FR) La structure bois

(IT) Struttura in legno

(NL) Houten structuur



(PL) Ułożenie kolejnych warstw. Sprawdzaj przekątną D po każdej ułożonej warstwie.

(FR) L'assemblage des couches suivantes. Vérifiez les diagonales "D" après la pose de chaque tour.

(GB) Putting next layers. Check D diagonals every layer.

(IT) La messa degli strati successivi. Trova la diagonale D dopo ogni strato.

(D) Verlegen der nachfolgenden Schichten. Nach Verlegen von jeder Schicht kontrollieren Sie die D-Diagonale.

(NL) Installeer de volgende lagen en controleer diagonaal D.

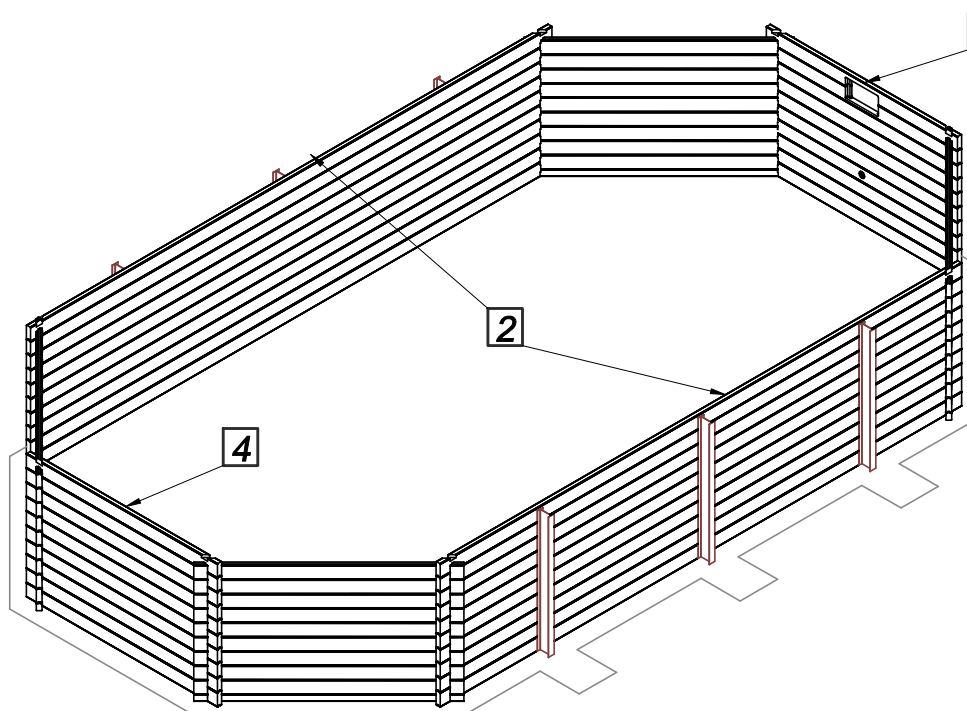
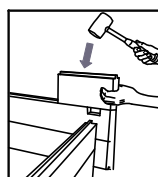
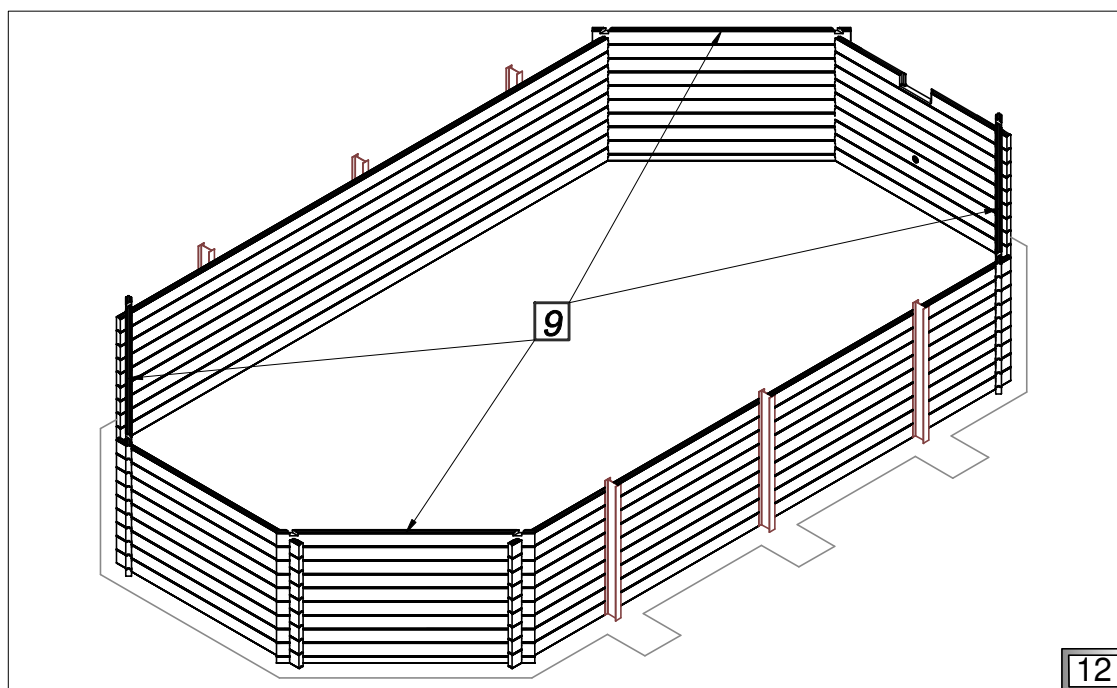
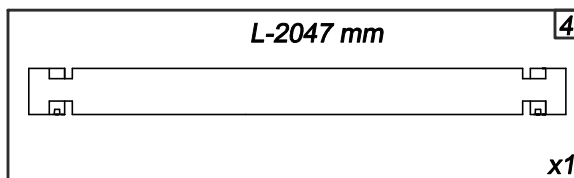
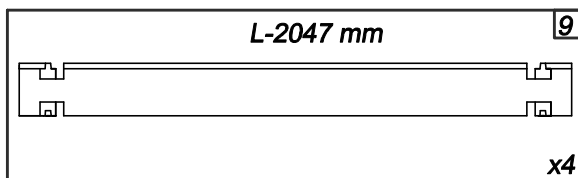
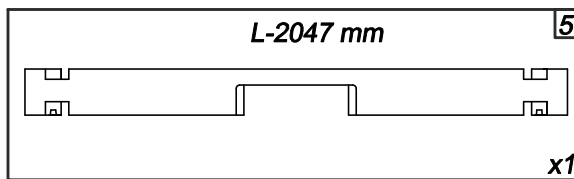
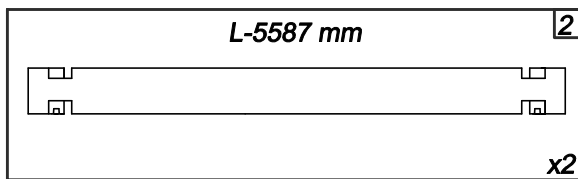

PL Struktura drewniana

GB Wooden structure

D Holzstruktur

FR La structure bois

IT Struttura in legno

NL Houten structuur



PL Ułożenie kolejnych warstw. Sprawdzaj przekątną D po każdej ułożonej warstwie.

FR L'assemblage des couches suivantes. Vérifiez les diagonales "D" après la pose de chaque tour.

GB Putting next layers. Check D diagonals every layer.

IT La messa degli strati successivi. Trova la diagonale D dopo ogni strato.

D Verlegen der nachfolgenden Schichten. Nach Verlegen von jeder Schicht kontrollieren Sie die D-Diagonale.

NL Installeer de volgende lagen en controleer diagonaal D.

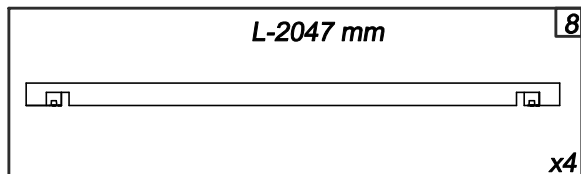

XI

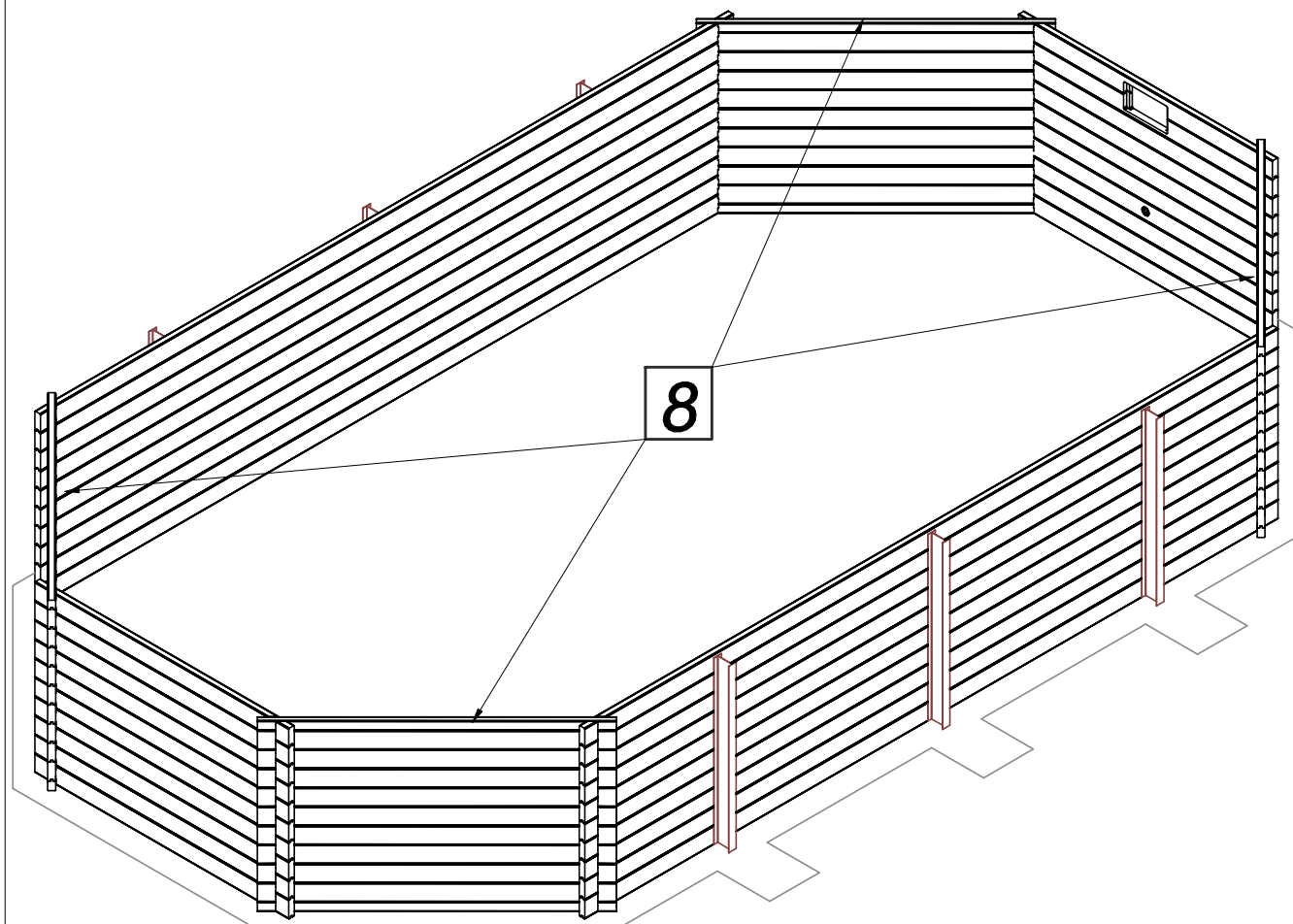
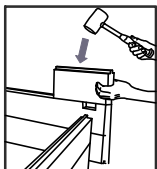

PL Struktura drewniana

GB Wooden structure

D Holzstruktur

FR La structure bois

IT Struttura in legno

NL Houten structuur



- PL** Montaż wspornika schodów (17).
- FR** Le montage du renfort d'escalier (17).
- GB** Installation of stairs support (17).
- IT** Montaggio delle scale a sbalzo (17).
- D** Montage von Treppenstützen(17).
- NL** Installatie van de steun voor de trap (17).

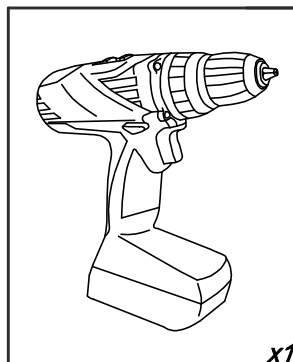

x1

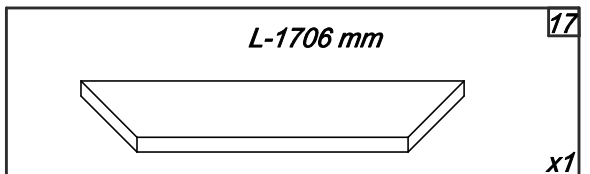

L-1706 mm

17

x1

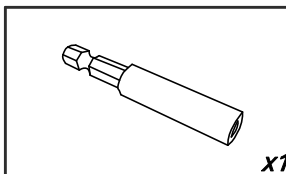

x1

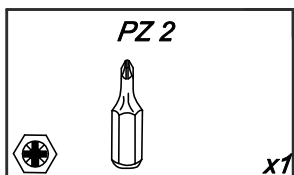

PZ 2



x1

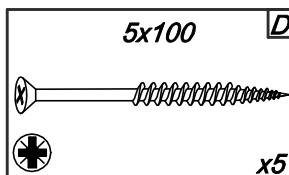

5x100

D



x5

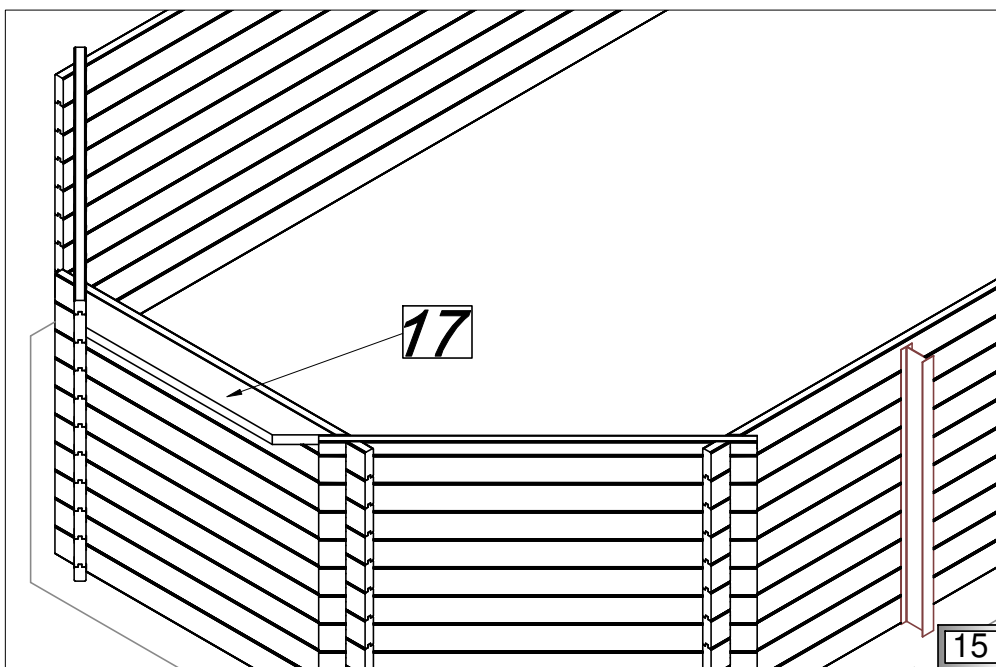

17

15

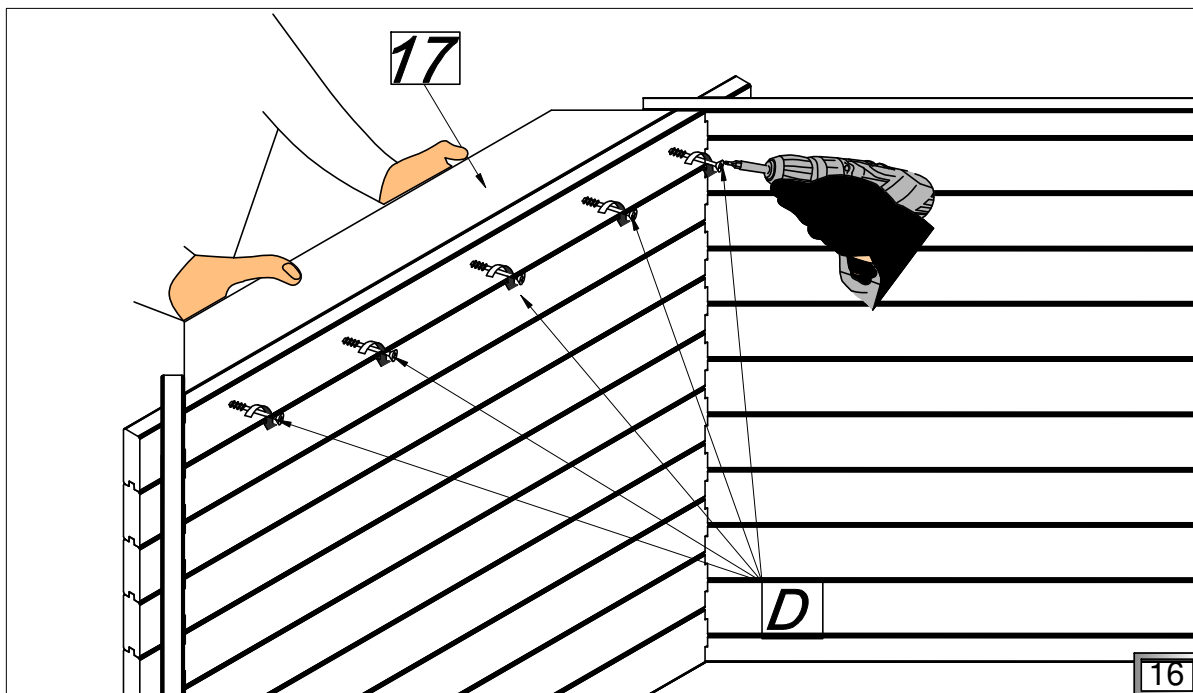

17

D

16

(PL) Struktura drewniana

(GB) Wooden structure

(D) Holzstruktur

(FR) La structure bois

(IT) Struttura in legno

(NL) Houten structuur



(PL) Rozłożenie wsporników pionowych (18, 19) oraz konsol (26) według schematu.

(FR) La disposition des renforts verticaux (18, 19) et des supports des margelles (26) d'après le schéma.

(GB) Arrangement of vertical supports (18, 19) and consoles (26) according to the drawing.

(IT) La distribuzione degli sbalzi verticali (18, 19) e delle console (26), secondo lo schema.

(D) Verteilung der vertikalen Stützen (18, 19) und Konsolen (26) nach Schema.

(NL) Montage van de verticale steunen (18, 19) en de consoles (26) volgens tekening.

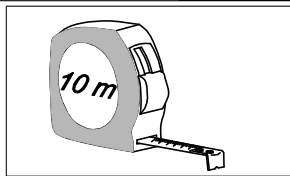

[mm]

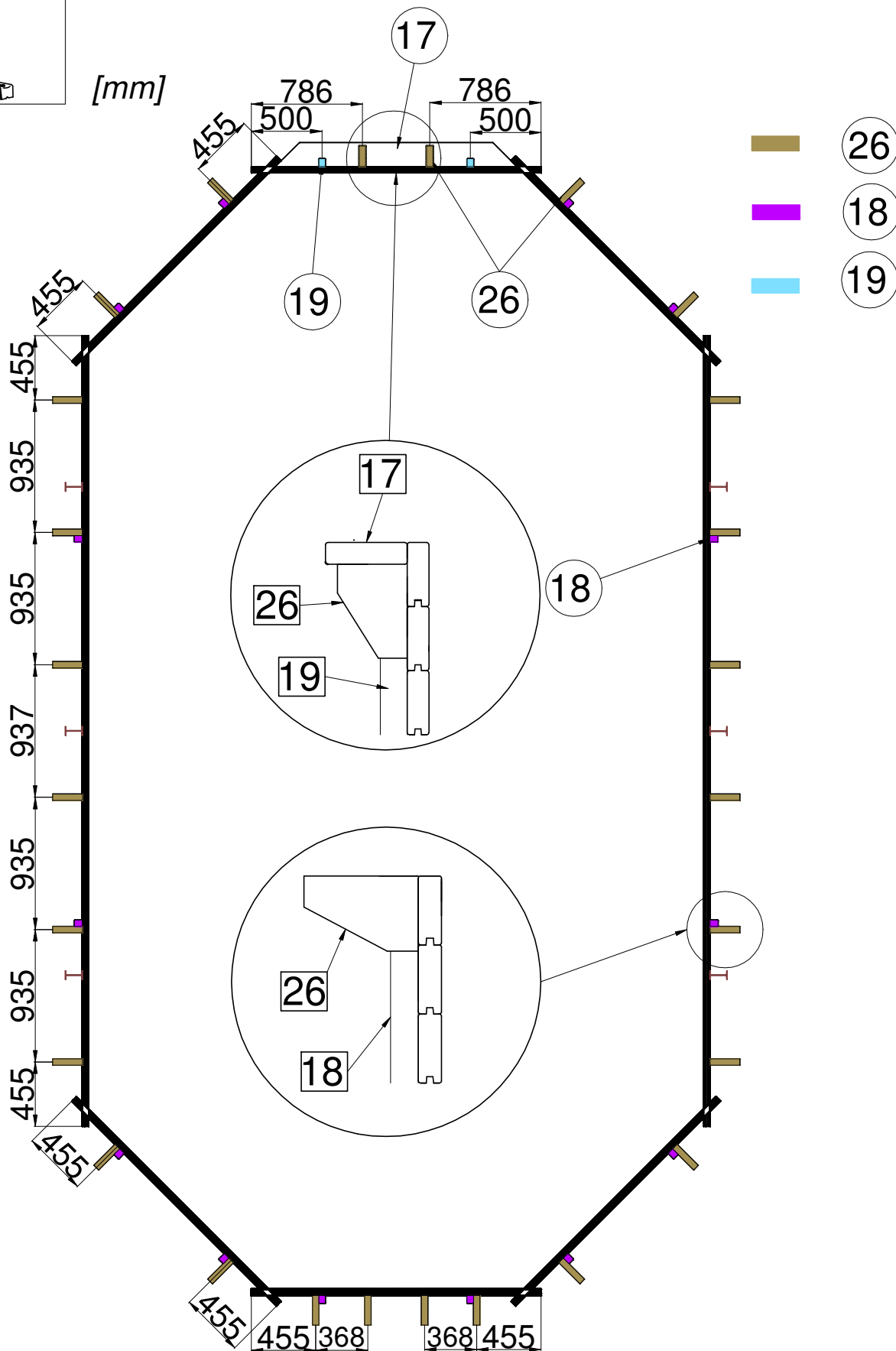

PL Struktura drewniana

GB Wooden structure

D Holzstruktur

FR La structure bois

IT Struttura in legno

NL Houten structuur



PL Montaż konsol (26). Konsole montowane pod wspomnikiem schodów (17) według rysunku 20;21.

FR Le montage des supports des margelles (26). Montez les supports des margelles sous un renfort d'escalier (17) d'après le dessin 21.

GB Installation of consoles (26). Consoles under ladder support (17) installed according to the drawing 20;21.

IT Il montaggio di console (26). Console sono montate sotto lo sbalzo della scala (17), come mostrato sul disegno 20;21.

D Konsolenmontage (26). Die Konsolen werden unter den Treppenstützen (17) nach Abb 20;21 montiert.

NL Installatie van de consoles (26). Consoles onder de ladder steun (17) volgens tekening 20;21.

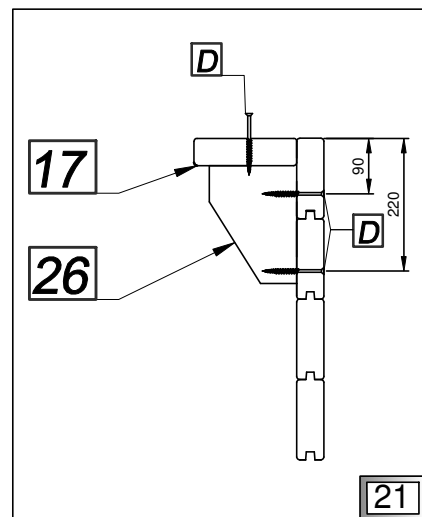
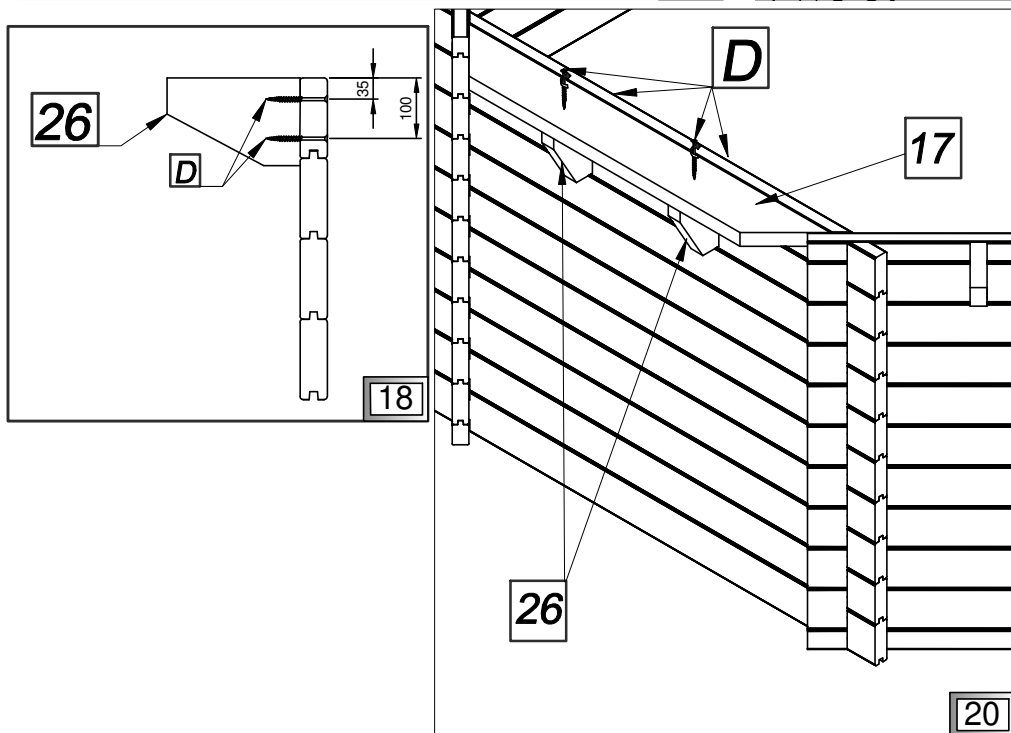
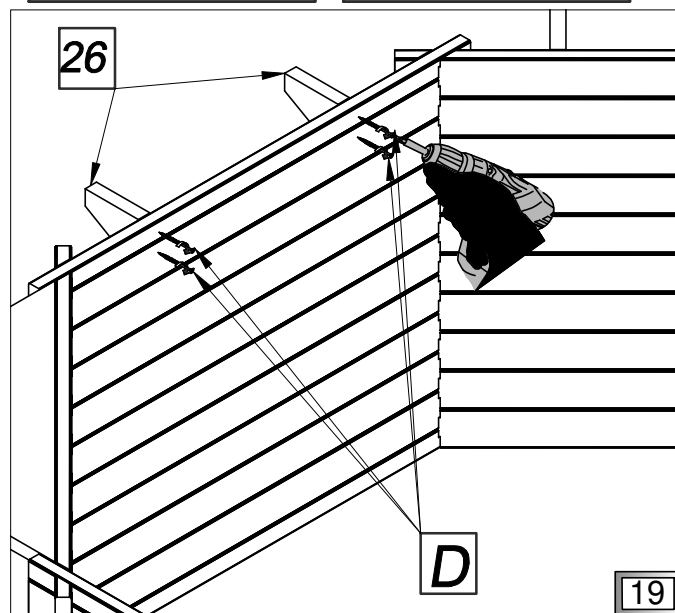
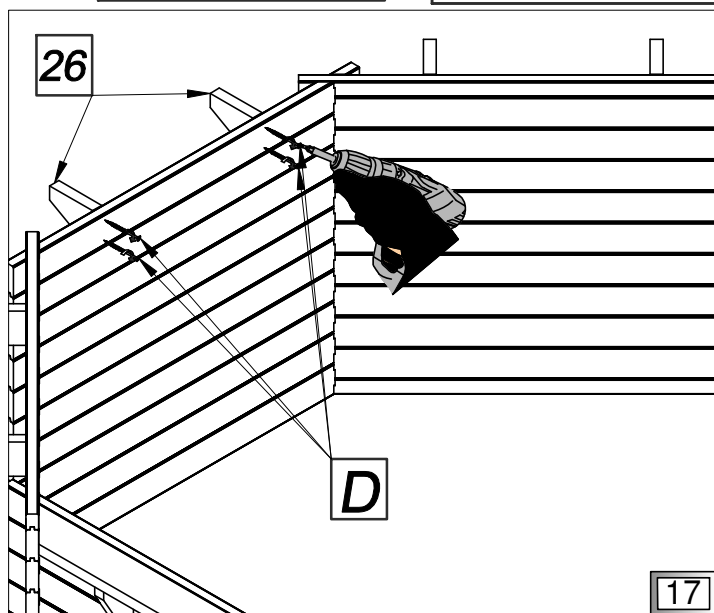
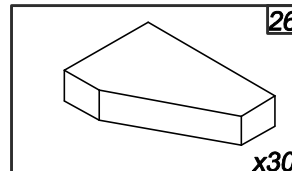
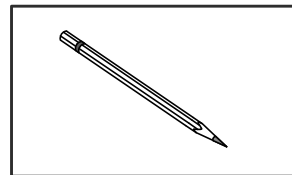
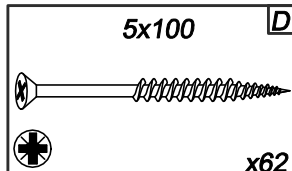
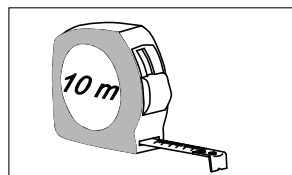
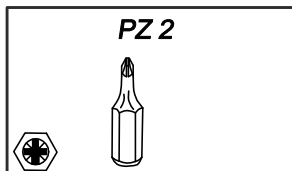
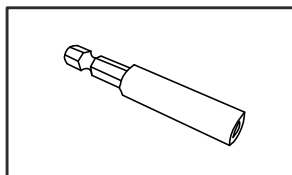
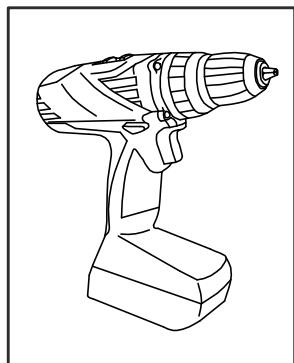

PL Struktura drewniana

GB Wooden structure

D Holzstruktur

FR La structure bois

IT Struttura in legno

NL Houten structuur



PL Montaż wsporników pionowych (18). Wkręty rozmieszczaj według rysunku 23.

FR Le montage des renforts verticaux (18). La disposition des vis d'après le dessin 23.

GB Installation of vertical supports (18). Arrange screws according to the drawing 23.

IT Montaggio degli sbalzi verticali (18). Mettere viti secondo il disegno 23.

D Montage von vertikalen Stützen (18). Schrauben sind nach Abb 23 angebracht.

NL Installatie van de verticale steunen (18), bepaal de schroeven volgens tekening 23.

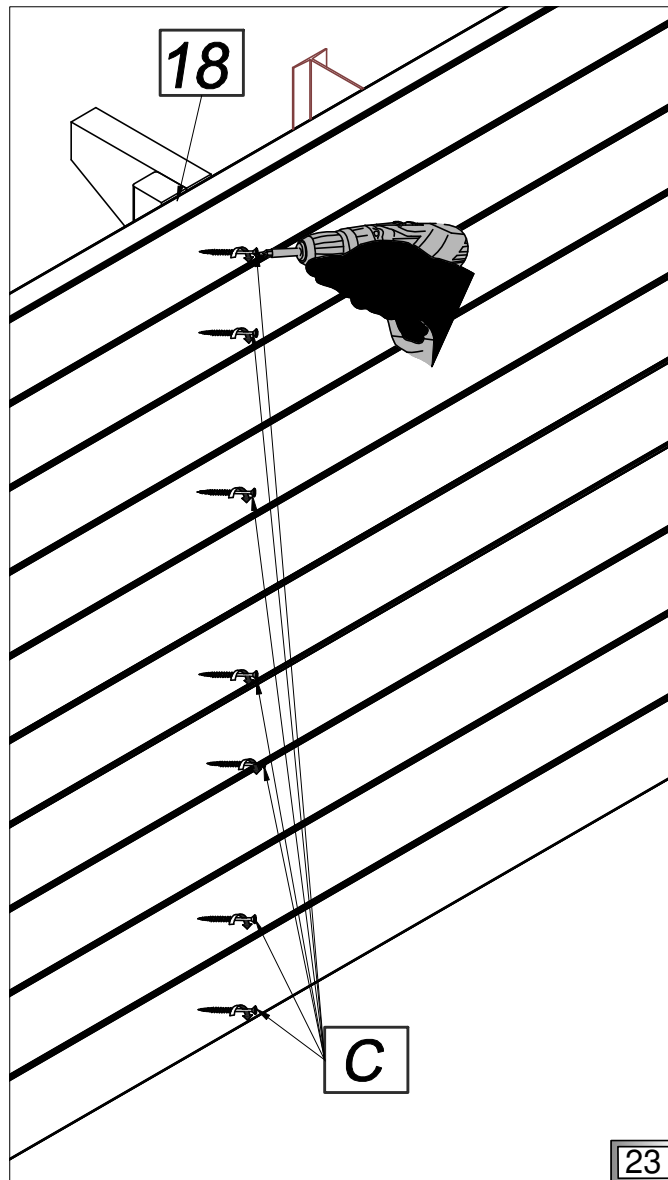
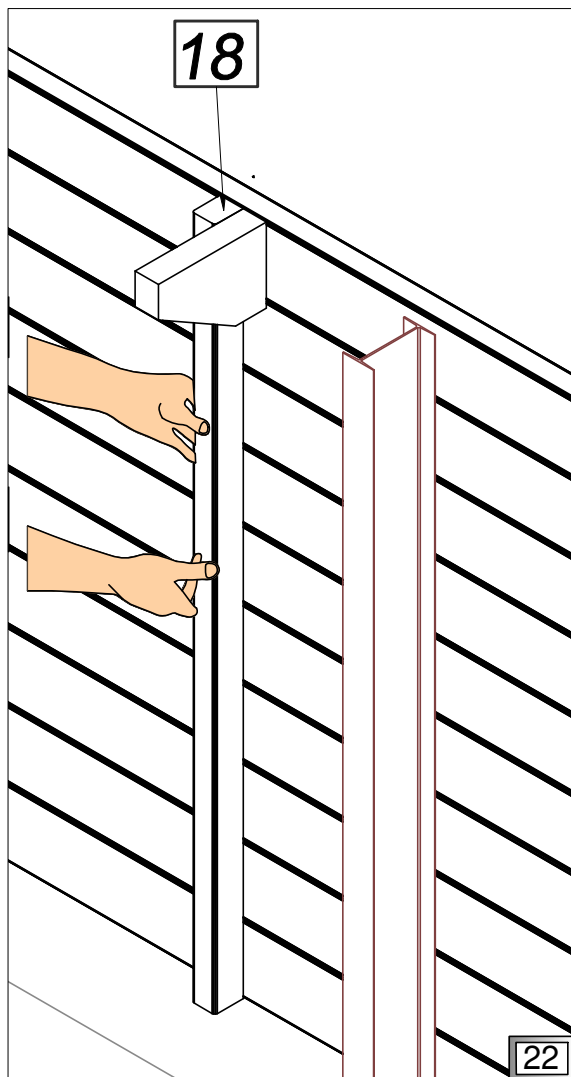
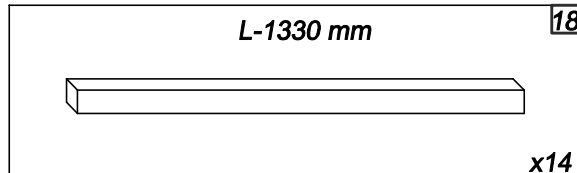
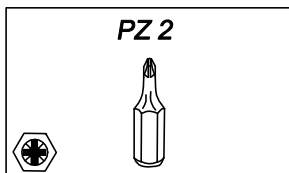
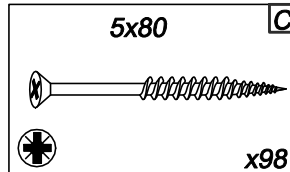
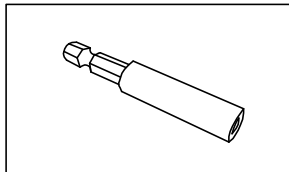
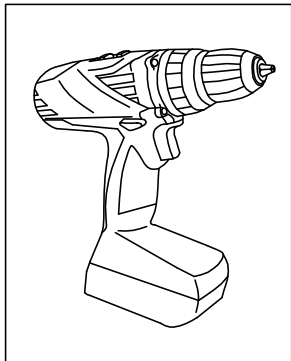

PL Struktura drewniana

GB Wooden structure

D Holzstruktur

FR La structure bois

IT Struttura in legno

NL Houten structuur



- PL** Montaż wsporników pionowych (19) pod wspomikiem schodów (17).
- FR** Le montage des renforts verticaux (19) sous un renfort d'escalier (17).
- GB** Installation of vertical supports (19) under the ladder support (17).
- IT** Installazione degli sbalzi verticali (19) sotto lo sbalzo delle scale (17).
- D** Montage von vertikalen Stützen (19) unter den Treppenstützen (17).
- NL** Installatie van de verticale steunen (19) onder de ladder steun (17).

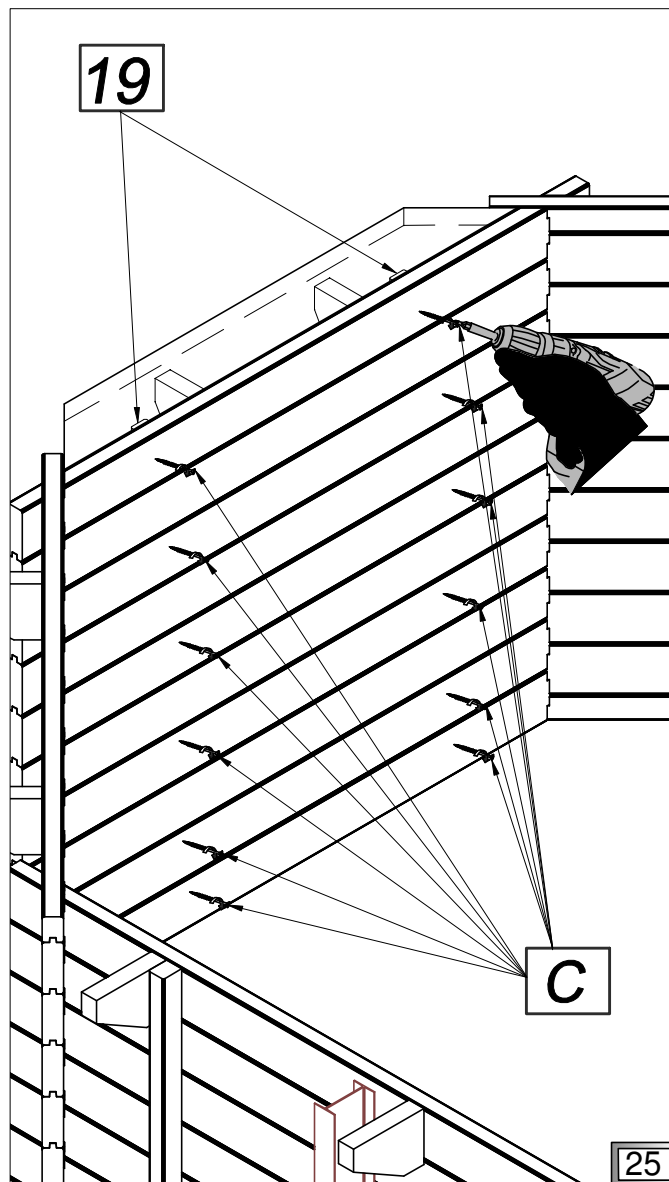
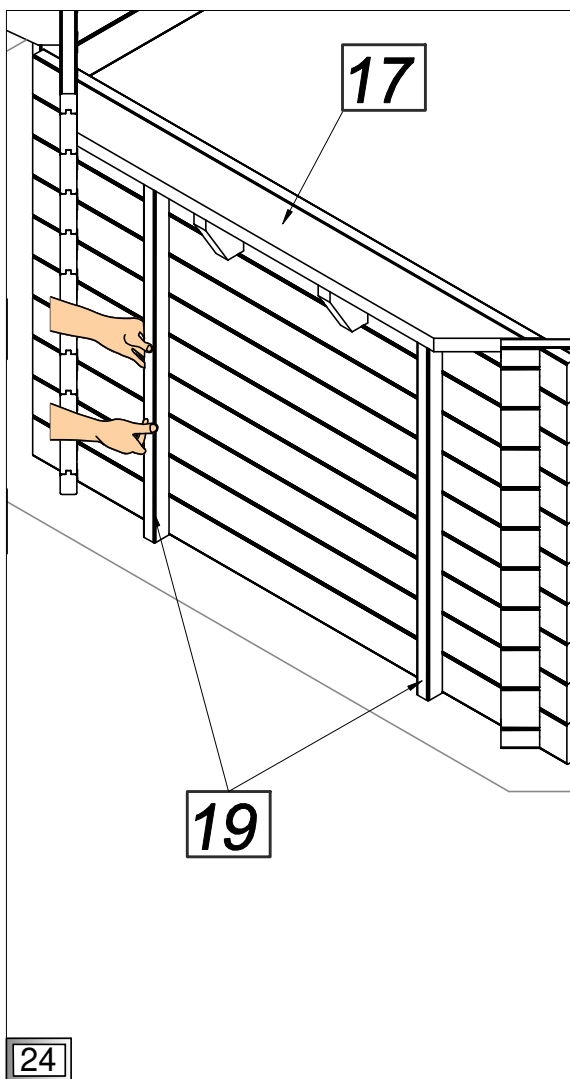
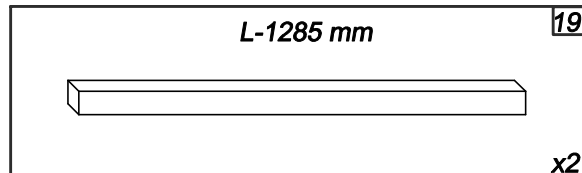
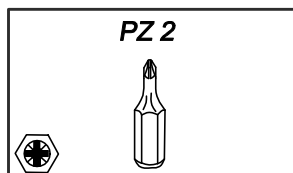
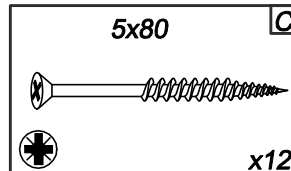
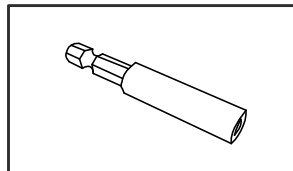
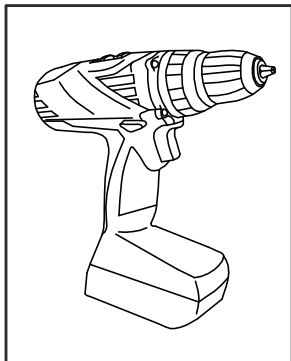

(PL) Struktura drewniana

(GB) Wooden structure

(D) Holzstruktur

(FR) La structure bois

(IT) Struttura in legno

(NL) Houten structuur



(PL) Montaż maskownicy 57 mm (25).

(FR) Le montage des caches 57 mm (25).

(GB) Installation of the masking element 57 mm (25).

(IT) Montaggio del mascherino 57 mm (25).

(D) Montage der Abdeckung 57 mm (25).

(NL) Installatie van de afwerklát 57mm (25) voor de kopse kanten van de wanddelen.

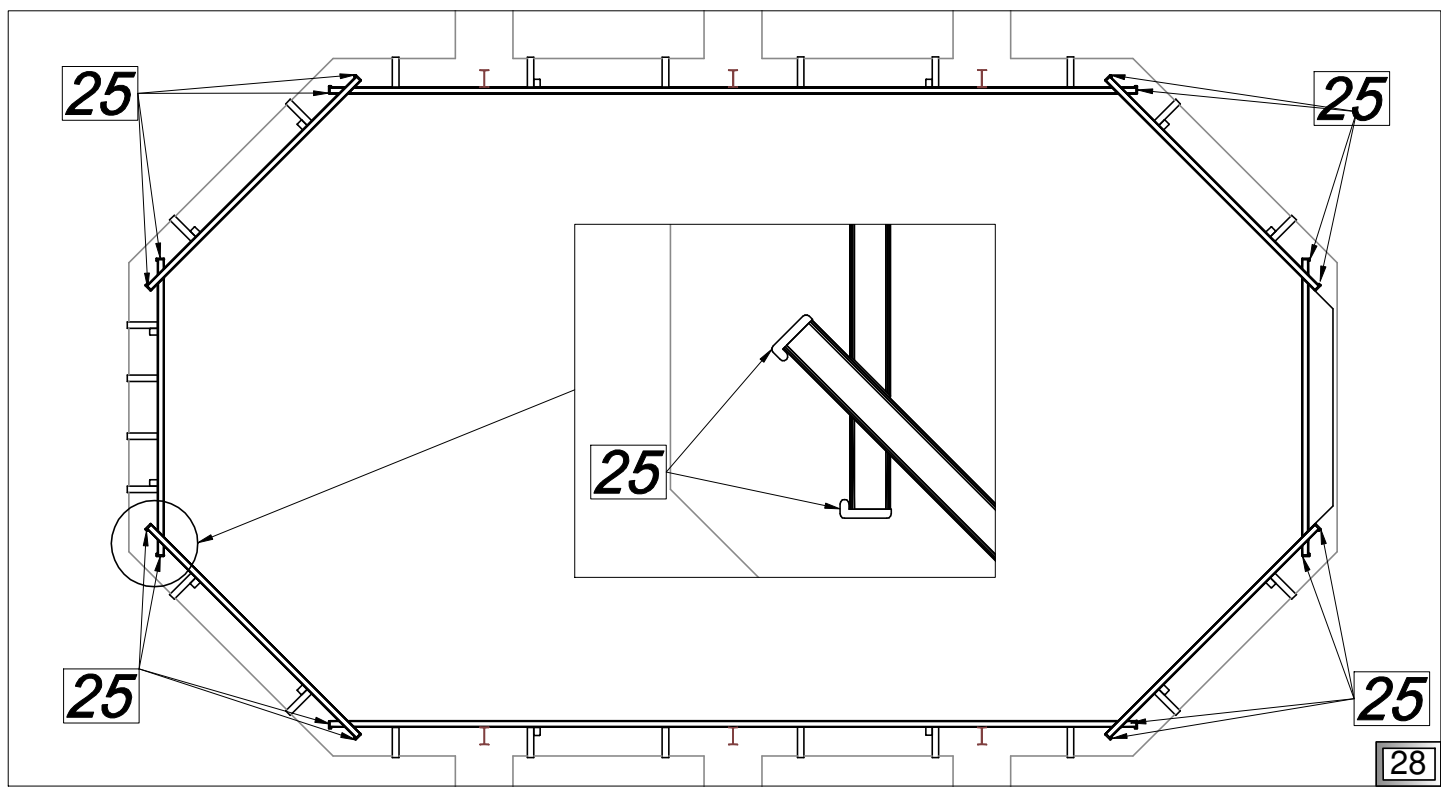
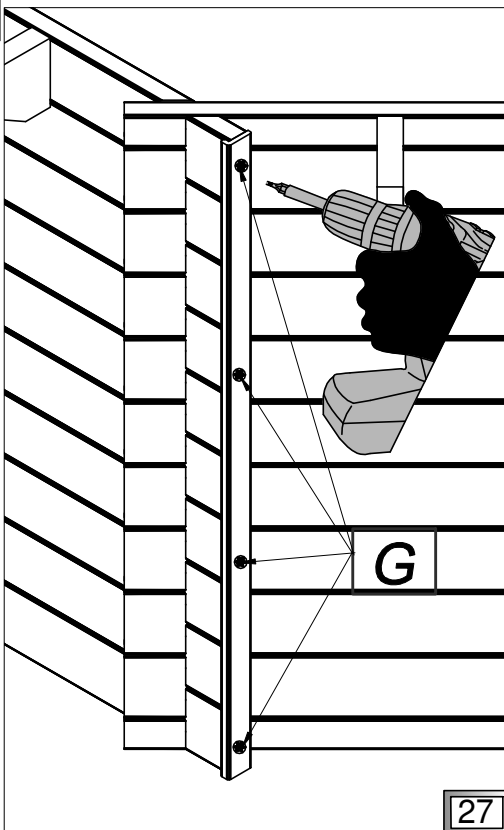
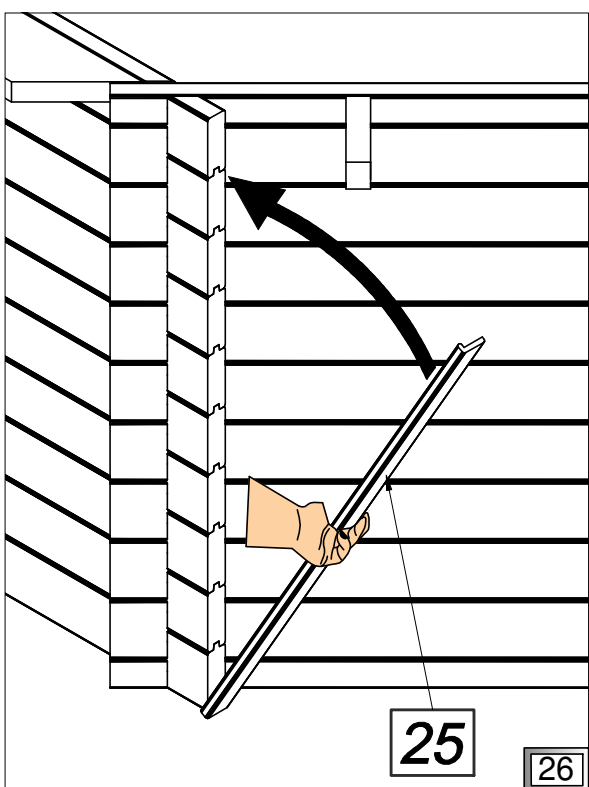
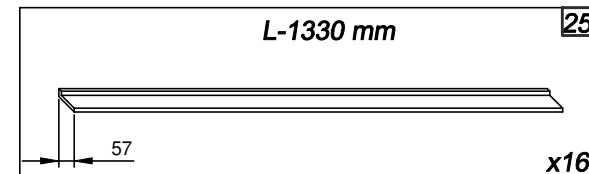
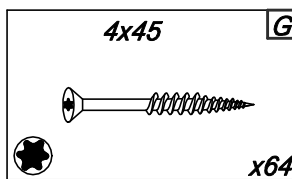
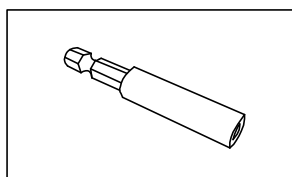
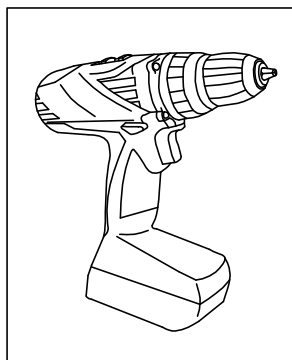

(PL) Struktura drewniana

(GB) Wooden structure

(D) Holzstruktur

(FR) La structure bois

(IT) Struttura in legno

(NL) Houten structuur



(PL) Maskowanie słupków metalowych 2T (I) maskownicami (24, 23).

(FR) La fixation des caches (24, 23) pour les poteaux métalliques 2T (I).

(GB) Covering steel bars 2T (I) with masking elements (24, 23).

(IT) Mascherare i pilastri di metallo 2T (I) con i mascherini (24, 23).

(D) Verdeckung von 2T-Metallsäulen (I) mit Abdeckungen (24, 23).

(NL) Afdekken van de stalen balken 2T (I) met afwerklatten (24, 23).

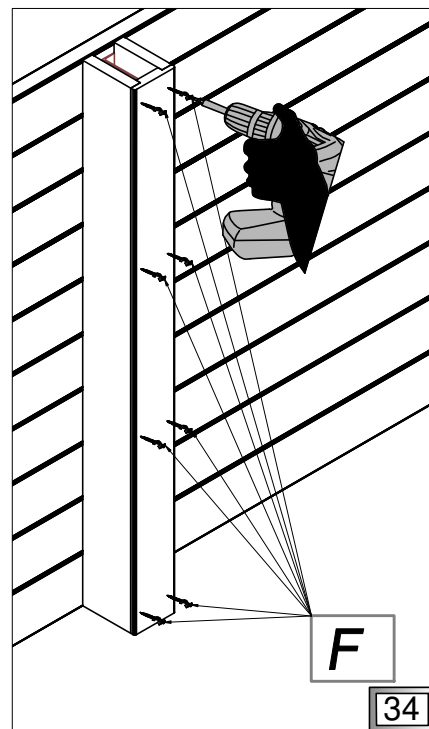
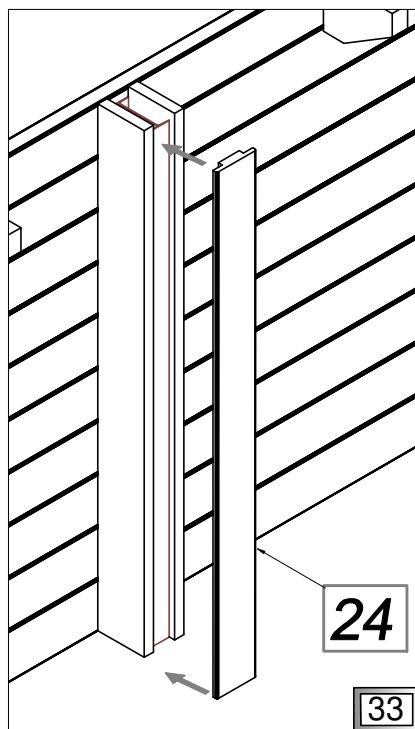
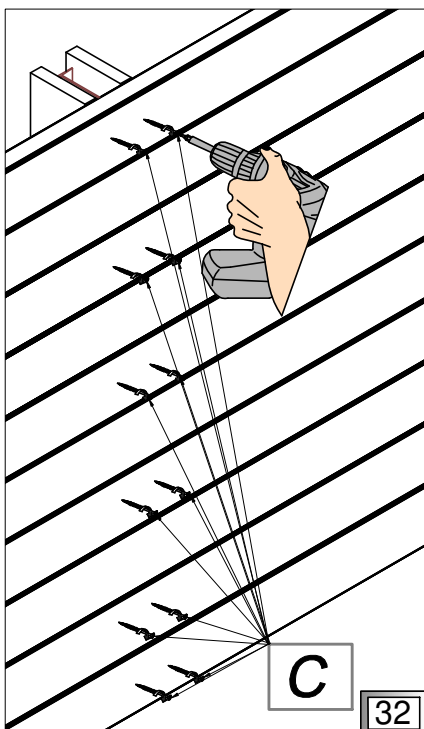
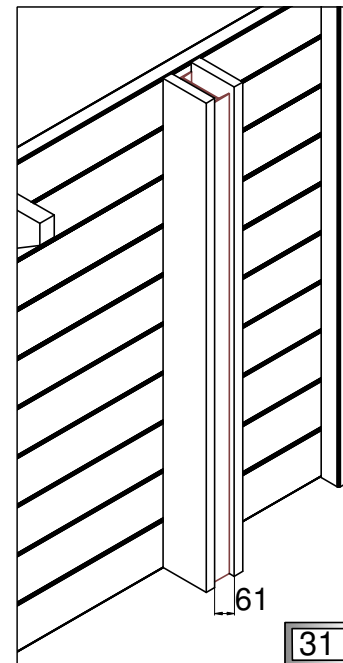
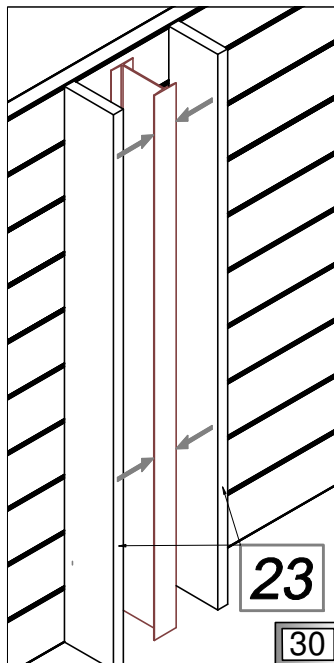
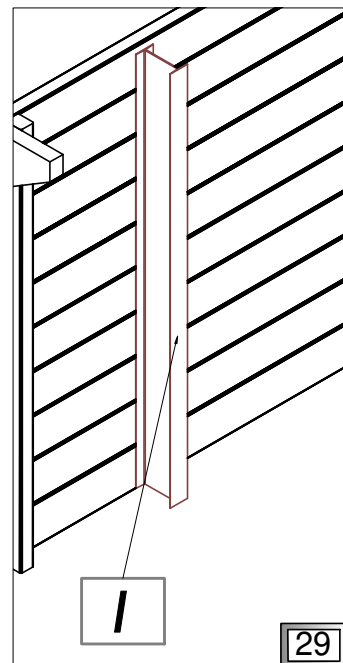
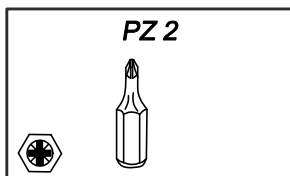
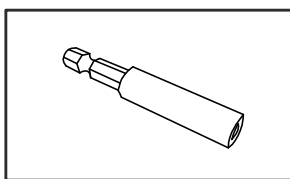
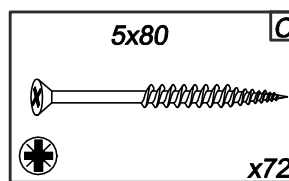
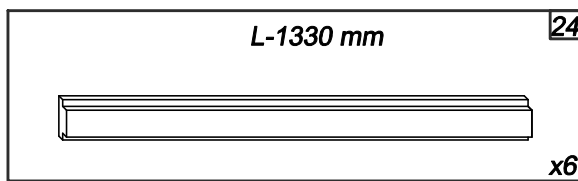
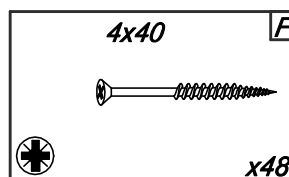
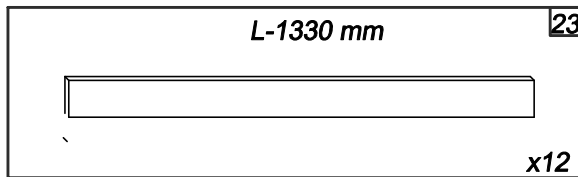
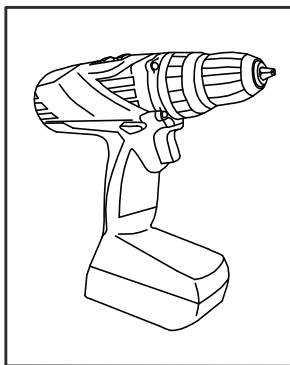

PL Geowłóknina

GB Geotextile

D Geotextilien

FR Le géotextile

IT Geotessile

NL Geotextiel



PL Rozłożenie geowłókniny (S). Nakleić włókninę na wewnętrzną stronę basenu za pomocą taśmy 2-stronnej bądź kleju.

FR La pose du feutre (S). Collez le feutre a l'interieur de la structure a l'aide de la colle ou du ruban adhésif double face.

GB The distribution of geotextile (S). Glue the geotextile to the inner side of pool wall. Use double-side tape or glue.

IT La distribuzione di geotessile (S). Incollì il geotessile al lato interno di muro di piscina. Usa nastro a due facce o colla.

D Die Verteilung von geotextile (S). Kleben Sie den geotextile an die innere Seite der Wand. Brauchen Sie zweiseitiges Band oder Leim.

NL De verdeling van de geotextiel (S). Lijm het vezelvlies op de binnenwand van het zwembad door middel van dubbelzijdig plakband of lijm.

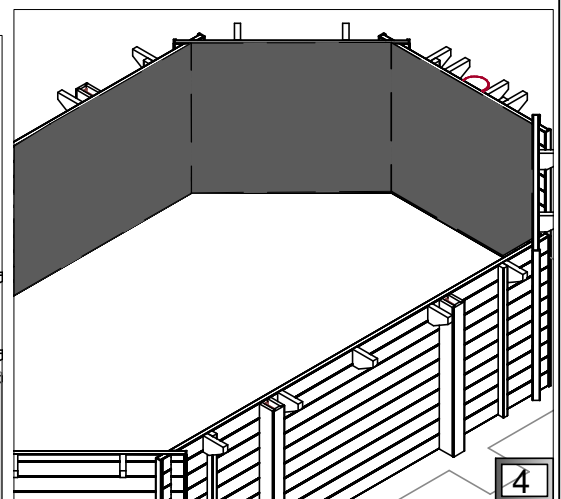
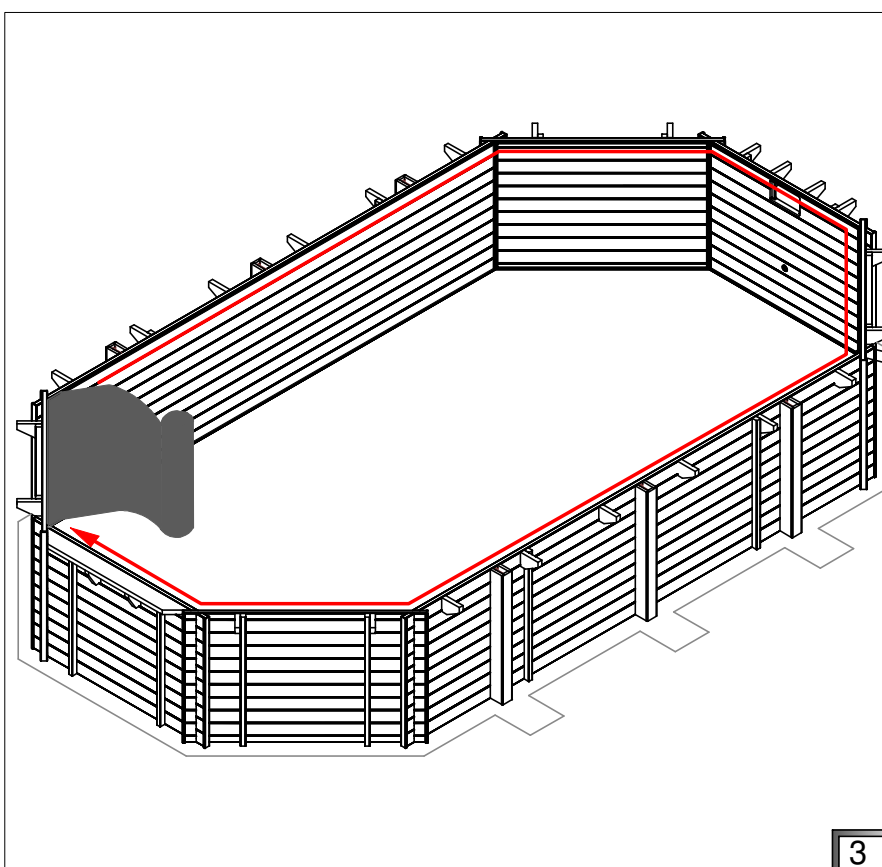
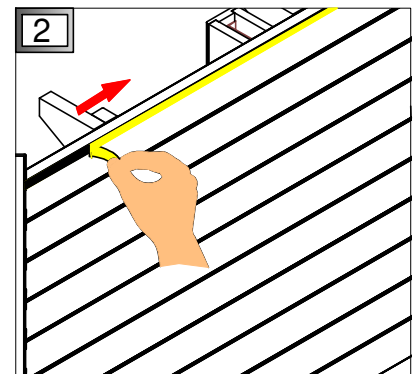
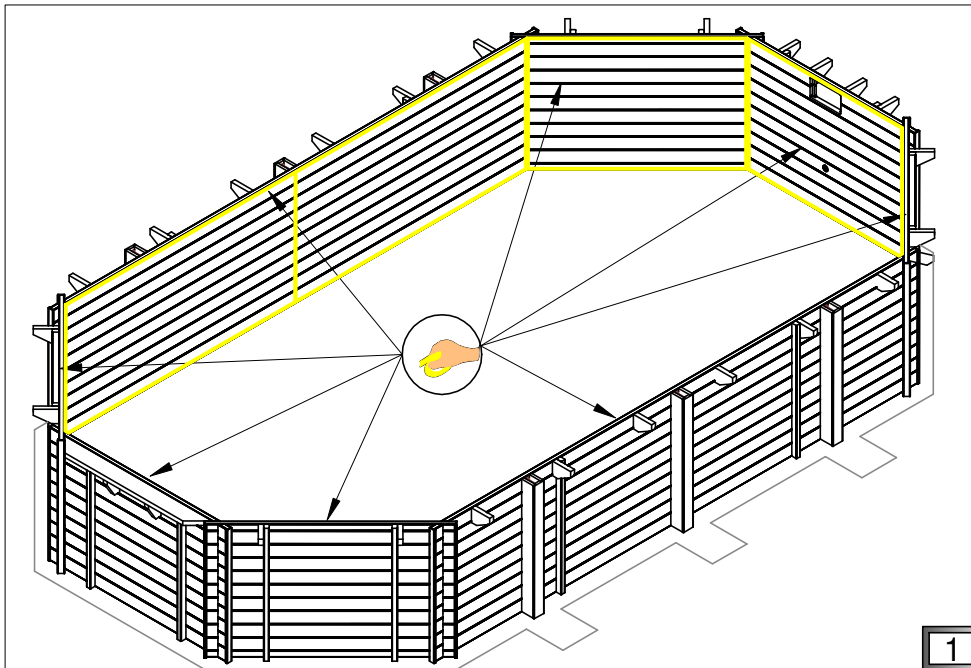
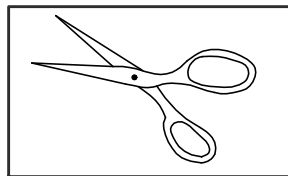
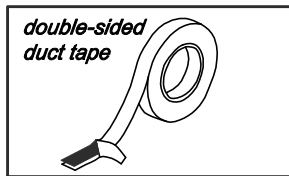
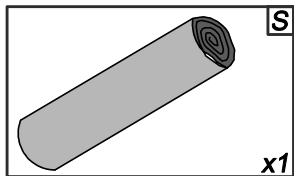

(PL) Profile PVC

(GB) PVC profiles

(D) PVC-Profil

(FR) Les profils PVC

(IT) Profili in PVC

(NL) PVC profielen



(PL) Profile PVC (J) przyciąć na wymiar. Wykonać otwory \varnothing 2 mm wg schematu.

(FR) Coupez les profils (J) d'accrochage et faites les pré-perçements \varnothing 2 mm d'après le schéma.

(GB) Cut PVC profiles (J) according to the drawing. Make holes \varnothing 2 mm according to the scheme.

(IT) Profili in PVC (J) adattare alla dimensione. Eseguire due fori \varnothing 2 mm secondo lo schema.

(D) Die PVC-Profil (J) auf Maß schneiden. Die \varnothing 2 mm-Öffnungen nach Schema bohren.

(NL) Zaag de PVC profielen (J) volgens tekening. Maak gaten van 2 mm volgens schema.

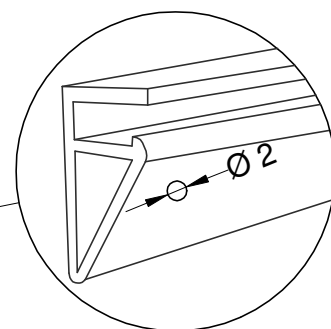
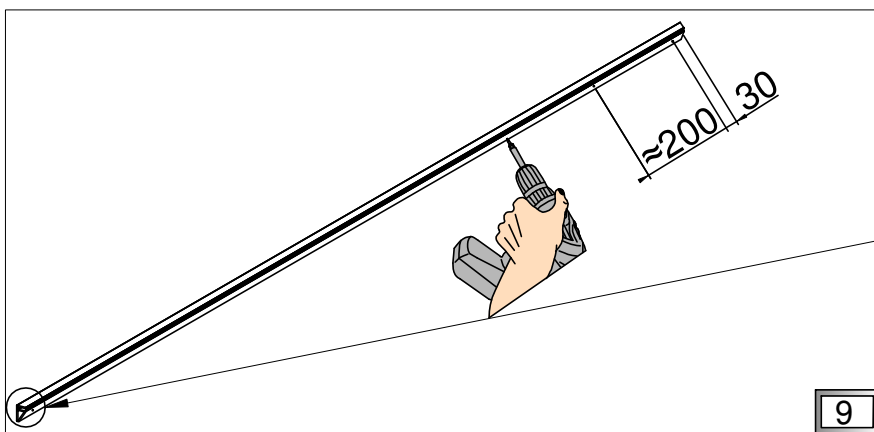
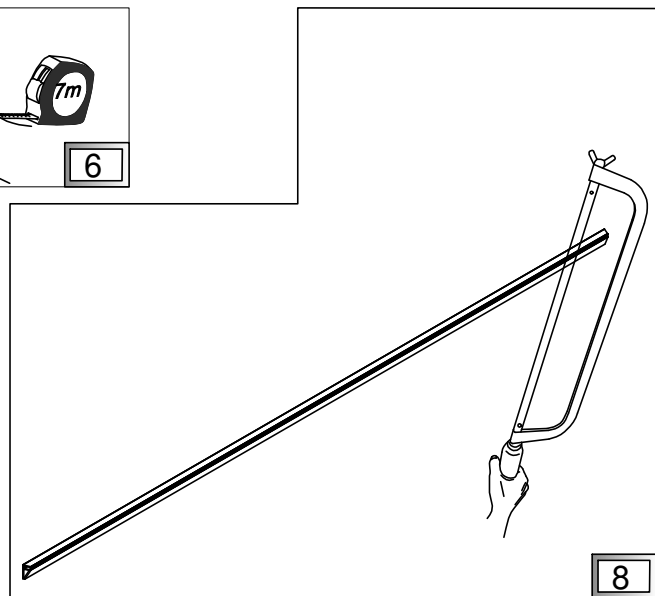
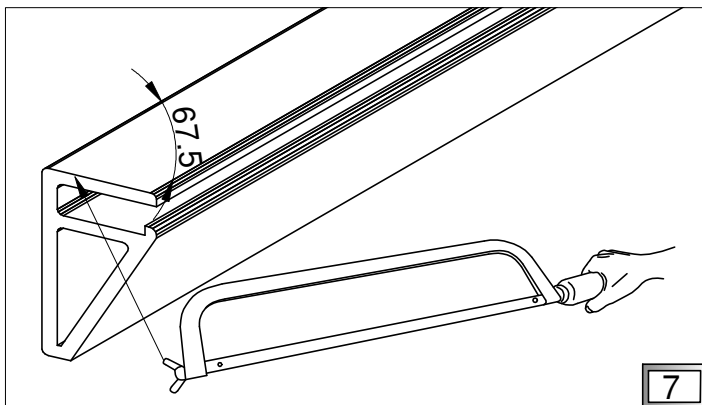
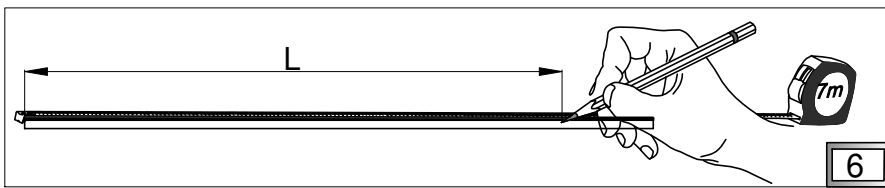
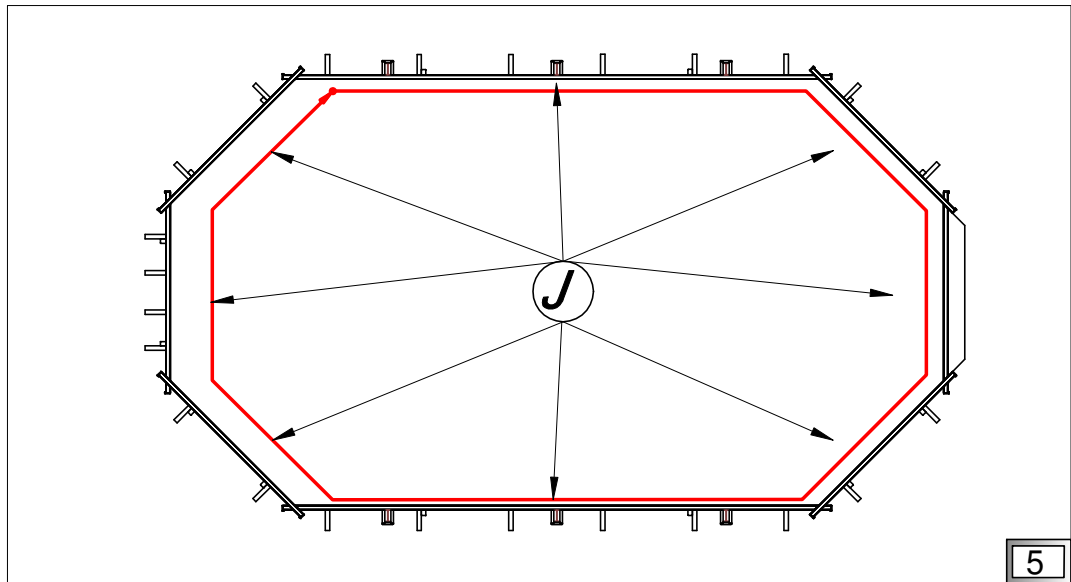
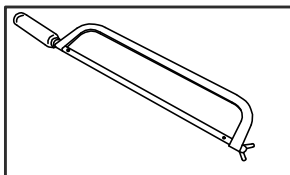
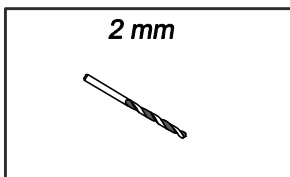
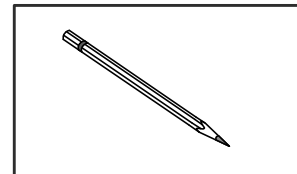
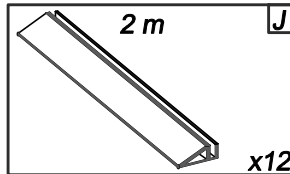
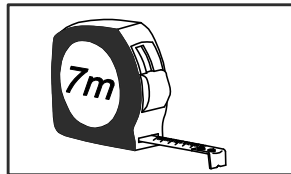
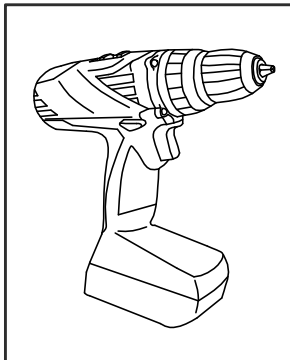

(PL) Profile PVC

(GB) PVC profiles

(D) PVC-Profile

(FR) Les profils PVC

(IT) Profili in PVC

(NL) PVC profielen



(PL) Montaż profili PVC (J) do struktury drewnianej. Profile (J) łączymy na żadaną długość.
(FR) Le montage des profils d'accrochage PVC (J) à la structure. Unissez les profils (J) à la longueur.
(GB) Mounting PVC profiles (J) to the wooden structure. Join profiles (J) to achieve desired length.
(IT) Il montaggio di profili in PVC (J) per strutture in legno. Il profili (J) combinare per la lunghezza desiderata.
(D) Montage von PVC-Profilen (J) an die Holzkonstruktion. Profile (J) sind nach der gewünschten Länge zu verbinden.
(NL) Montage PVC profielen (J) aan het houten frame en zaag de PVC profielen (J) in verstek om de hoeken passend te maken.

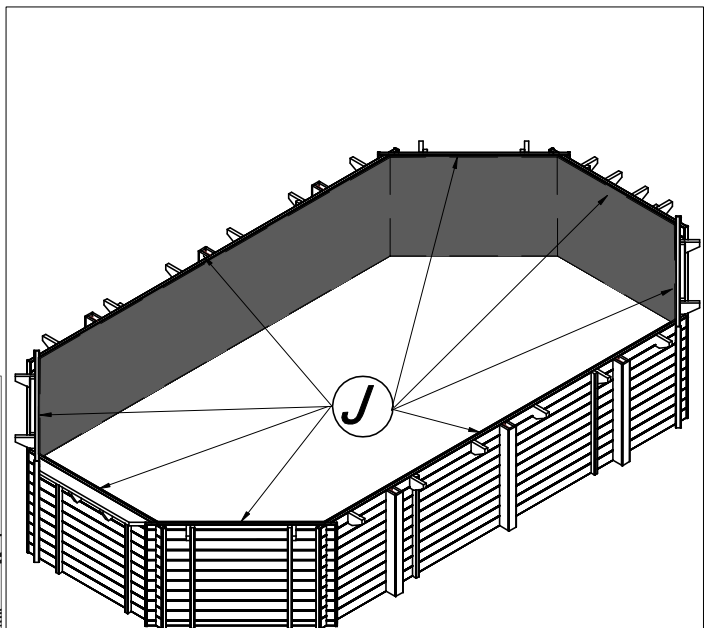
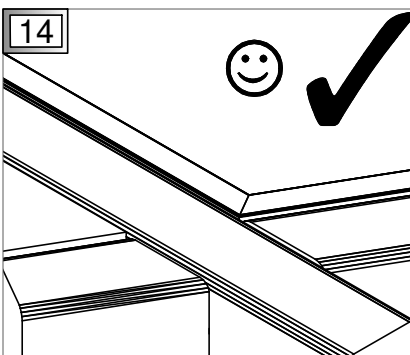
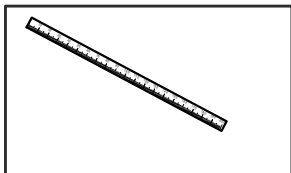
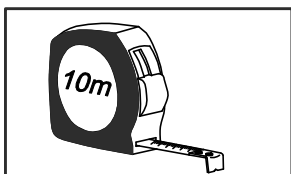
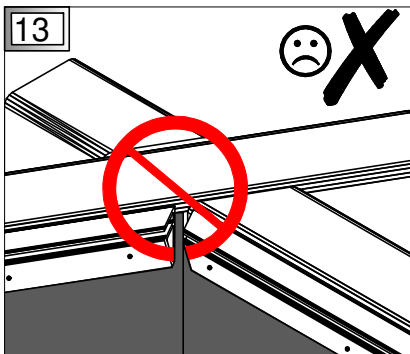
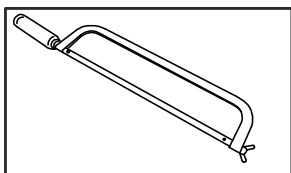
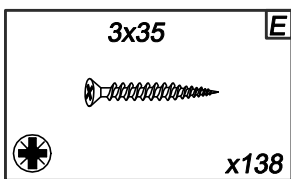
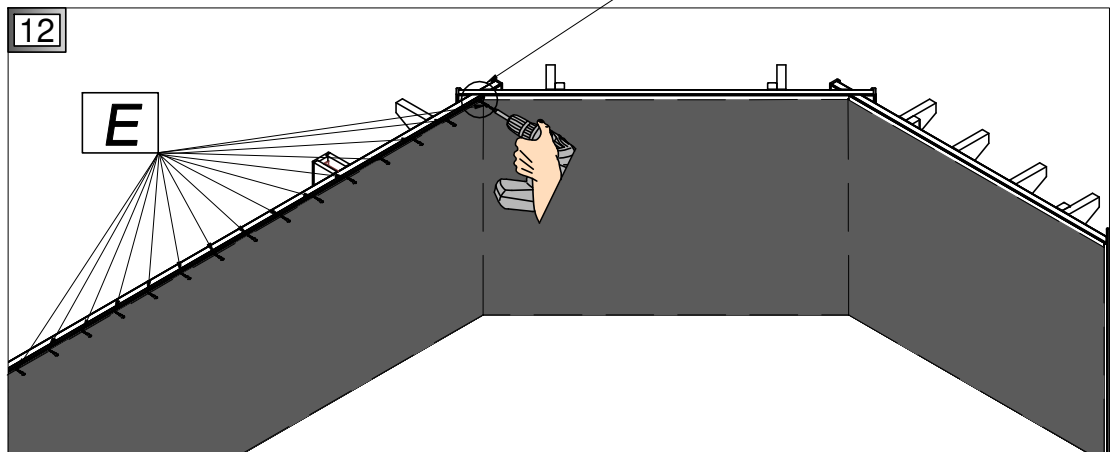
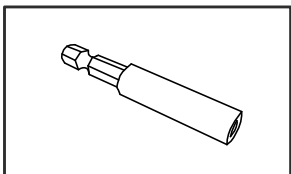
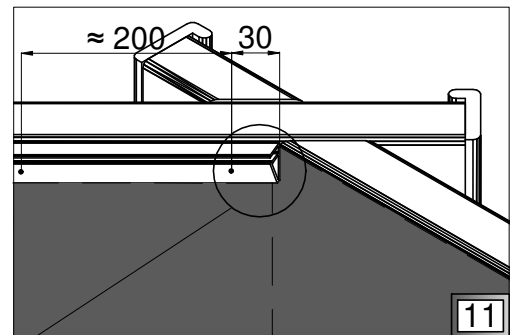
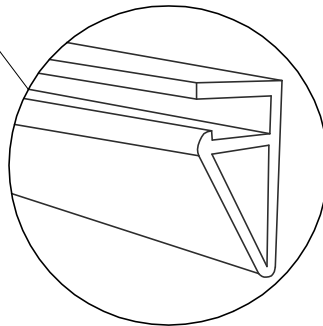
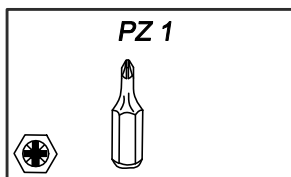
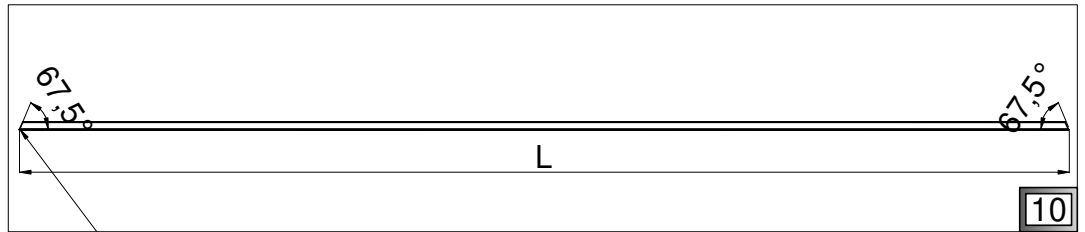
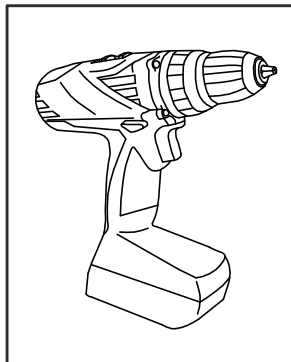

PL Geowłóknina i liner

GB Geotextile and liner

D Geotextilien und Liner

FR Le géotextile et la liner

IT Geotessile e liner

NL Geotextiel en liner



- PL** Rozłożenie geowłókniny (K)
- FR** La mise en place du feutre (K)
- GB** Installation of the geotextile (K)
- IT** Distribuzione di geotessile (K)
- D** Verteilung von Geotextilien (K)
- NL** Installatie van het geotextiel (K)

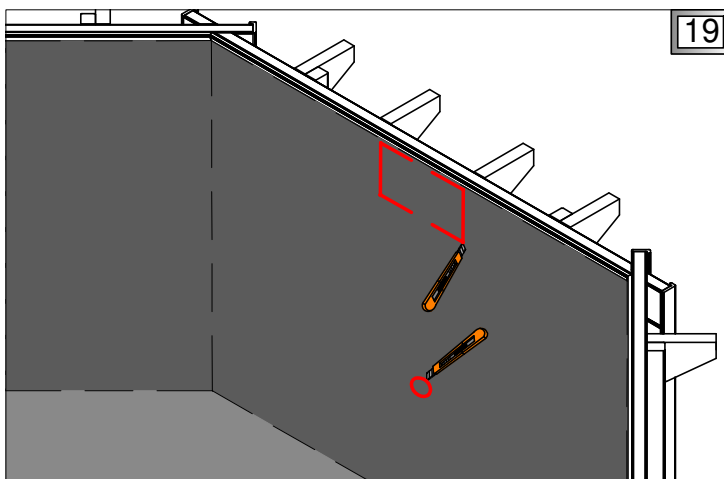
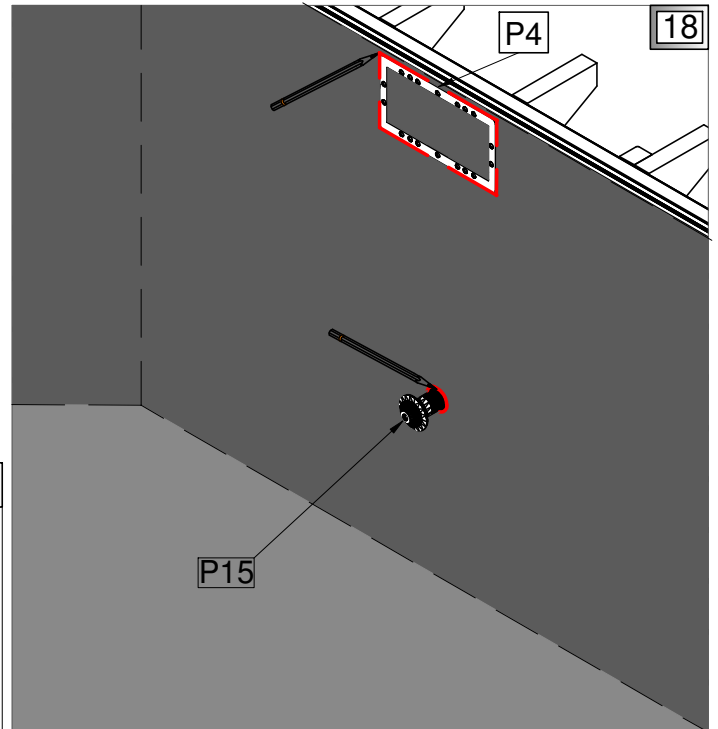
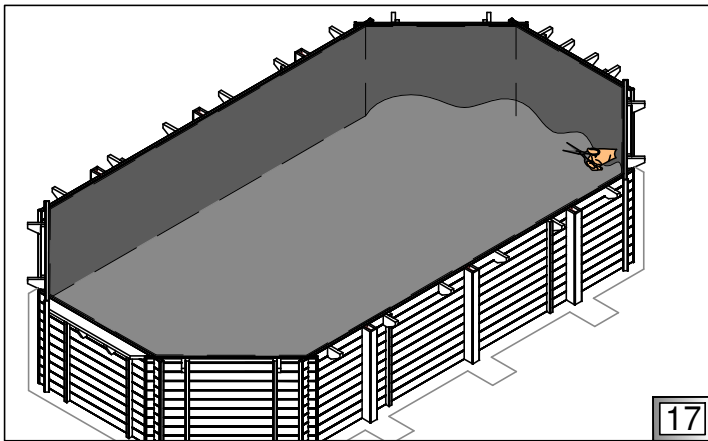
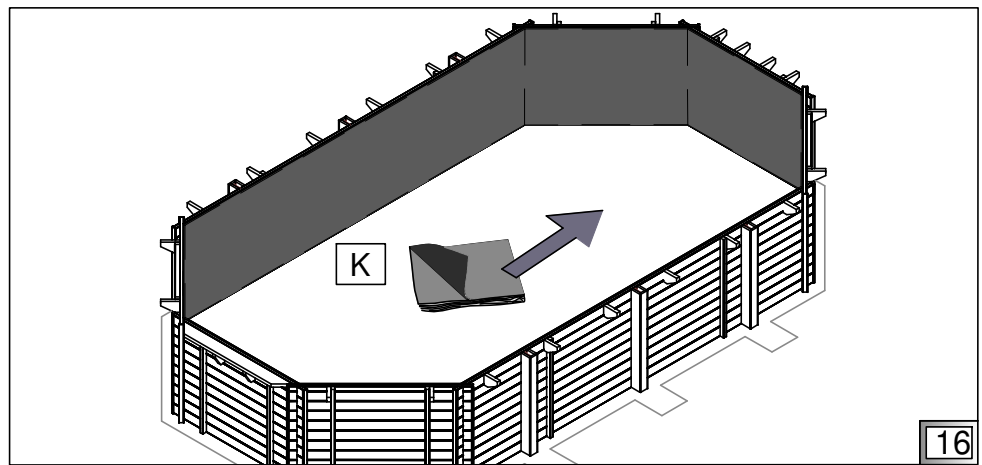
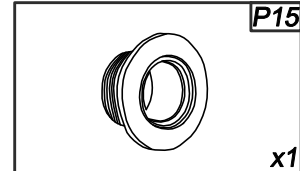
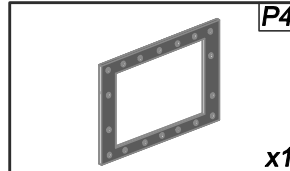
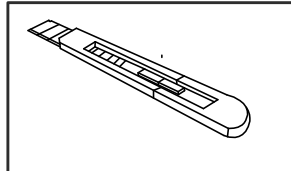
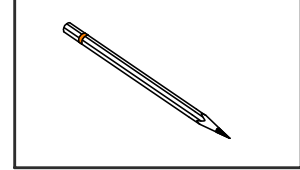
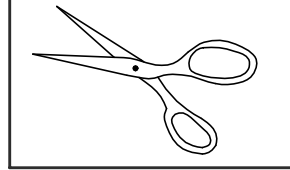
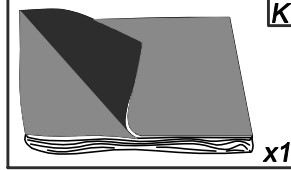
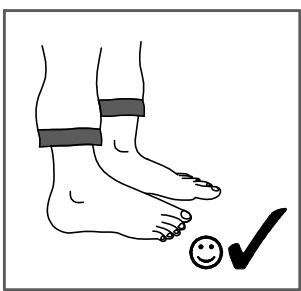

PL Skimmer

GB Skimmer

D Skimmer

FR Skimmer

IT Skimmer

NL Skimmer



PL Montaż skimmera.

FR Le montage du skimmer.

GB Installation of the skimmer.

IT L'installazione dello skimmer.

D Montage vom Skimmer.

NL Installeer de skimmer.

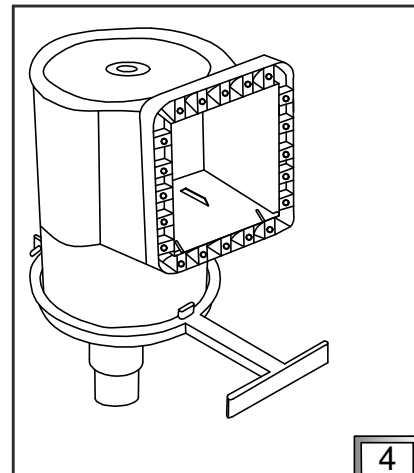
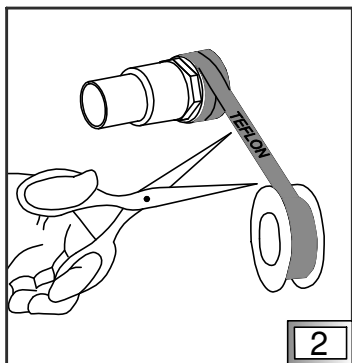
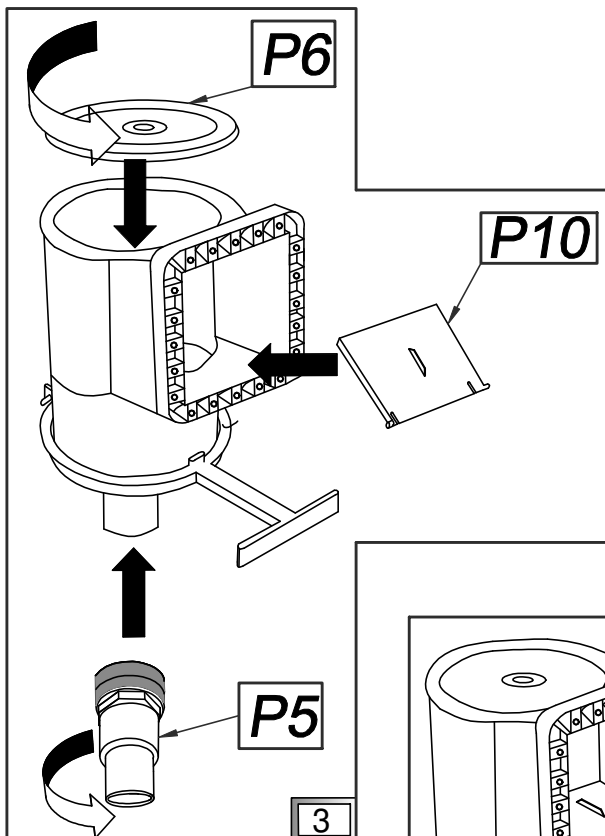
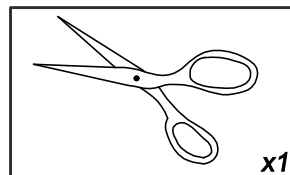
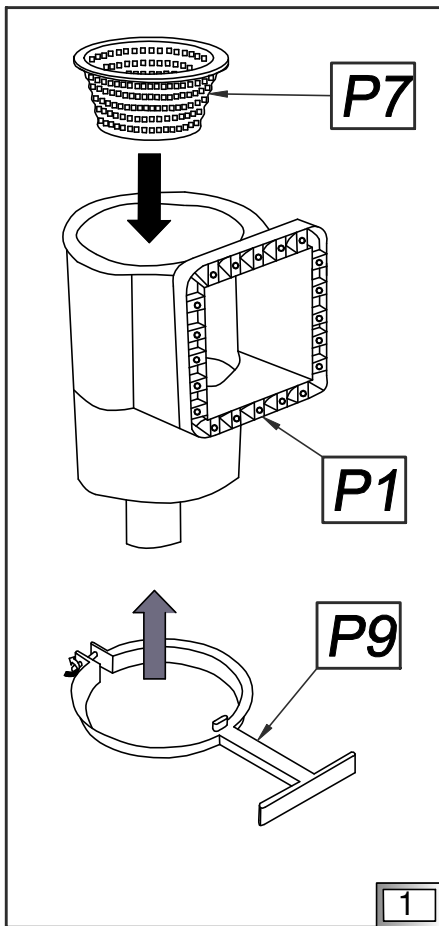
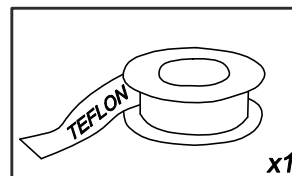
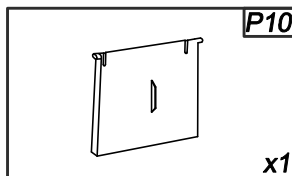
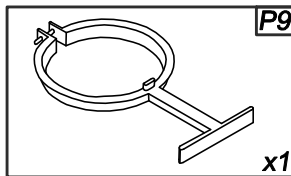
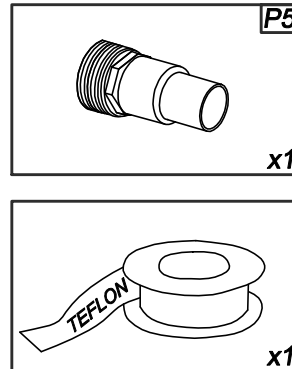
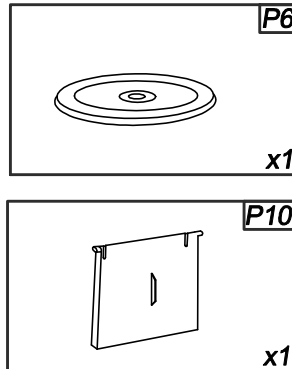
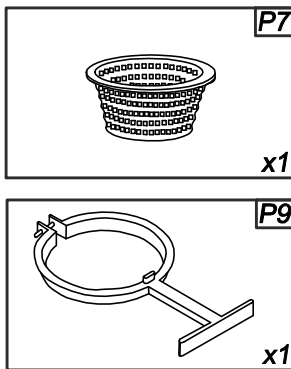
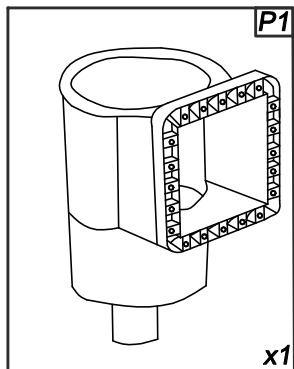

PL Skimmer

GB Skimmer

D Skimmer

FR Skimmer

IT Skimmer

NL Skimmer



PL Mocowanie skimmera do struktury drewnianej.

FR Le montage du skimmer à la structure.

GB Mounting skimmer to the wooden structure.

IT Attaccare lo skimmer alla struttura in legno.

D Befestigung von Skimmer an die Holzkonstruktion.

NL Montage skimmer aan de houten structuur.

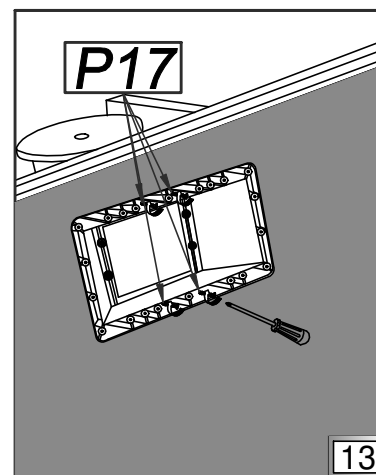
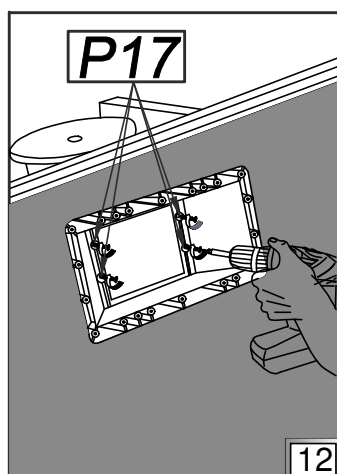
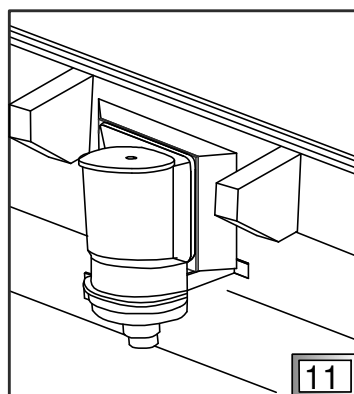
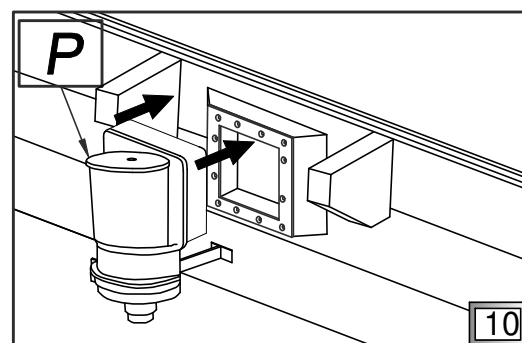
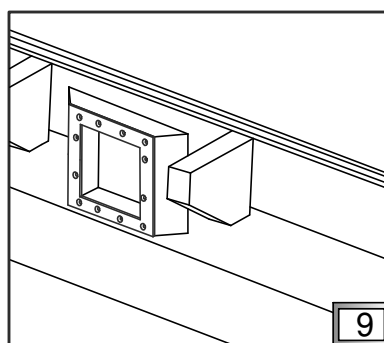
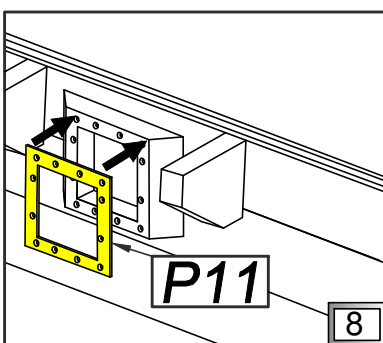
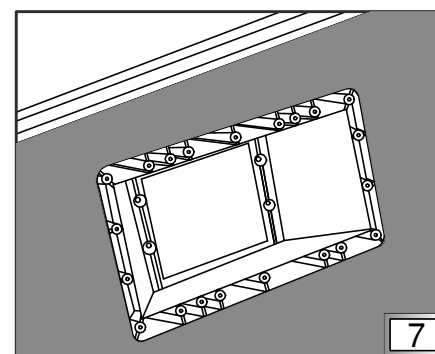
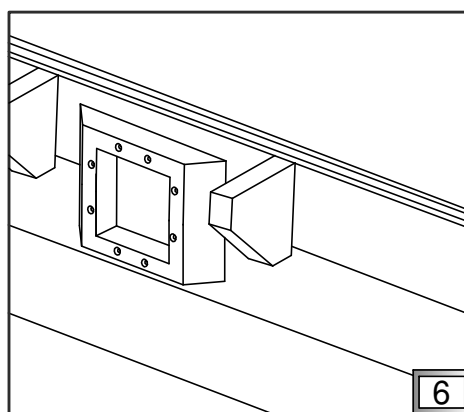
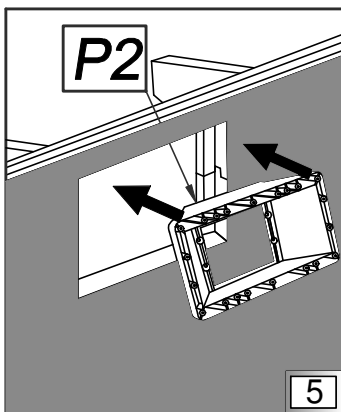
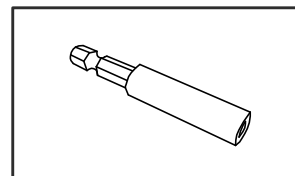
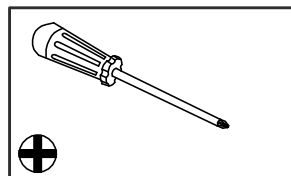
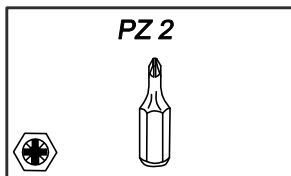
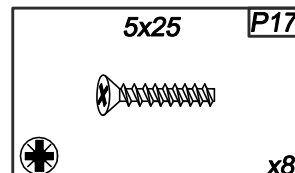
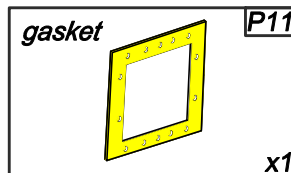
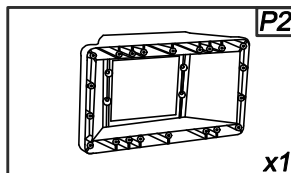
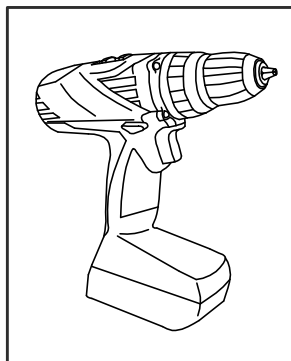

PL Skimmer

GB Skimmer

D Skimmer

FR Skimmer

IT Skimmer

NL Skimmer



PL Powierzchnię dyfuzora (P2) okleić taśmą dwustronną, następnie przykleić uszczelkę (P3).

FR Mettez sur la surface du diffuseur (P2) une adhésif double face et collez un joint (P3).

GB Use double-sided tape on the surface of the diffuser (P2), stick gasket (P3) to it.

IT La superficie del diffusore (P2) impiallacciare con un nastro biadesivo, poi attaccare la guarnizione (P3)

D Die Diffusorfläche mit dem doppelseitigen Klebeband bekleben, anschließend die Dichtung ankleben.

NL Plak dubbelzijdige tape op het oppervlak van het rooster (P2) plak de pakking (P3) hier op.

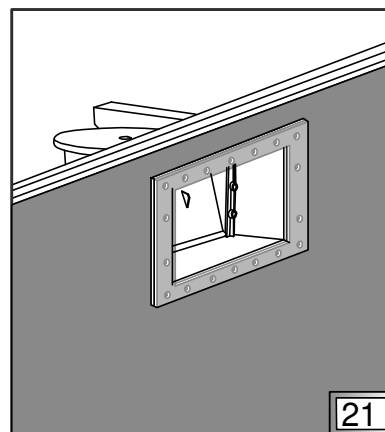
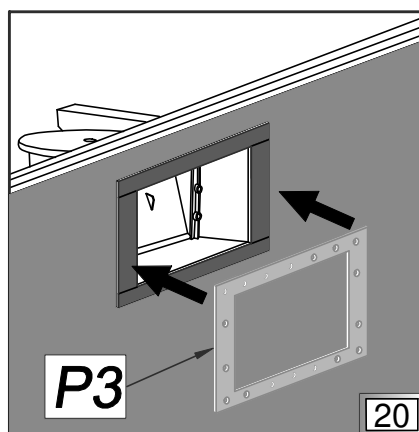
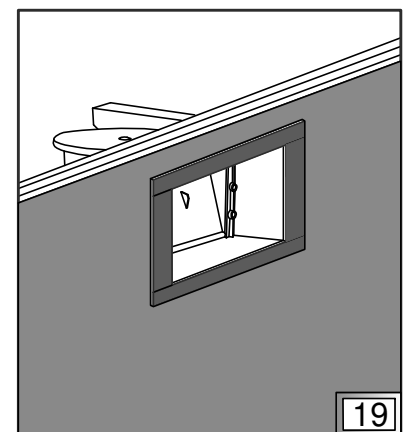
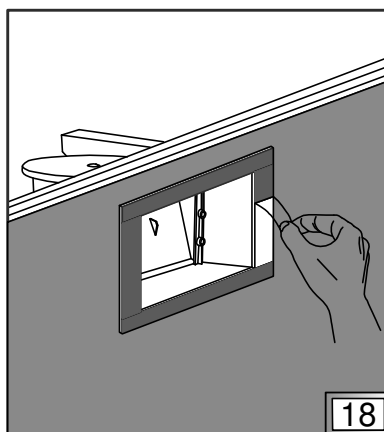
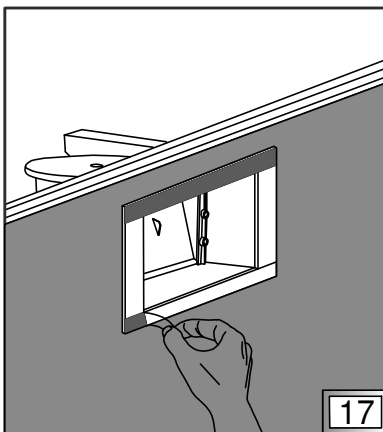
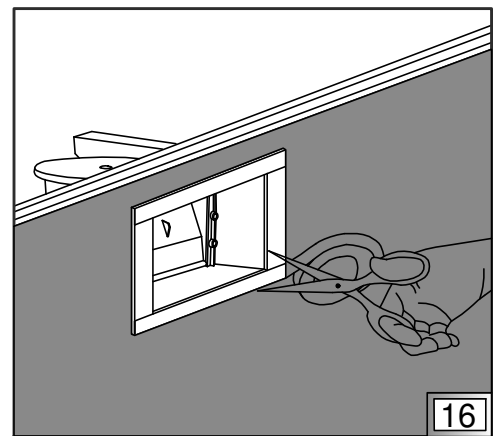
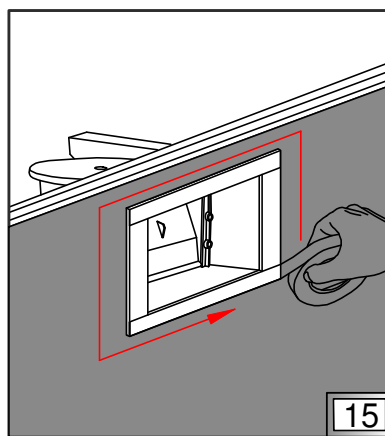
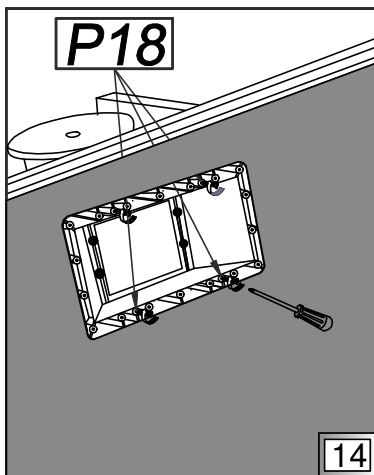
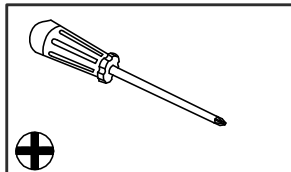
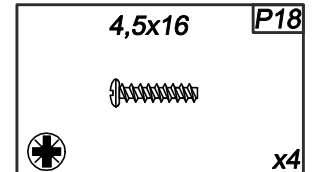
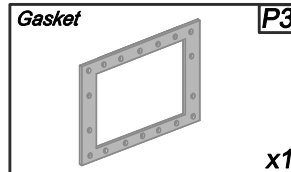
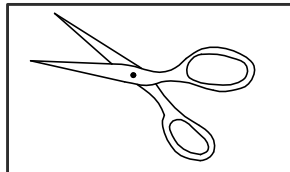
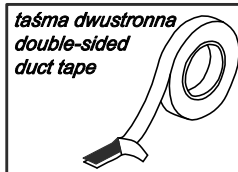

PL Liner

GB Liner

D Liner

FR Liner

IT Liner

NL Binnen bekleding



- PL** Montaż linera oraz stopera (L) w profilach PVC (J).
- FR** Le montage de la liner et de la bandelette (L) pour les profils d'accrochage (J).
- GB** Mounting the liner and liner lock (L) in PVC profiles (J).
- IT** Il montaggio di liner e tappo (L) in profili in PVC (J).
- D** Montage von Liner und von Stopper (L) in den PVC-Profilen (J).
- NL** Montage van de binnen bekleding (L) in de PVC profielen (J).

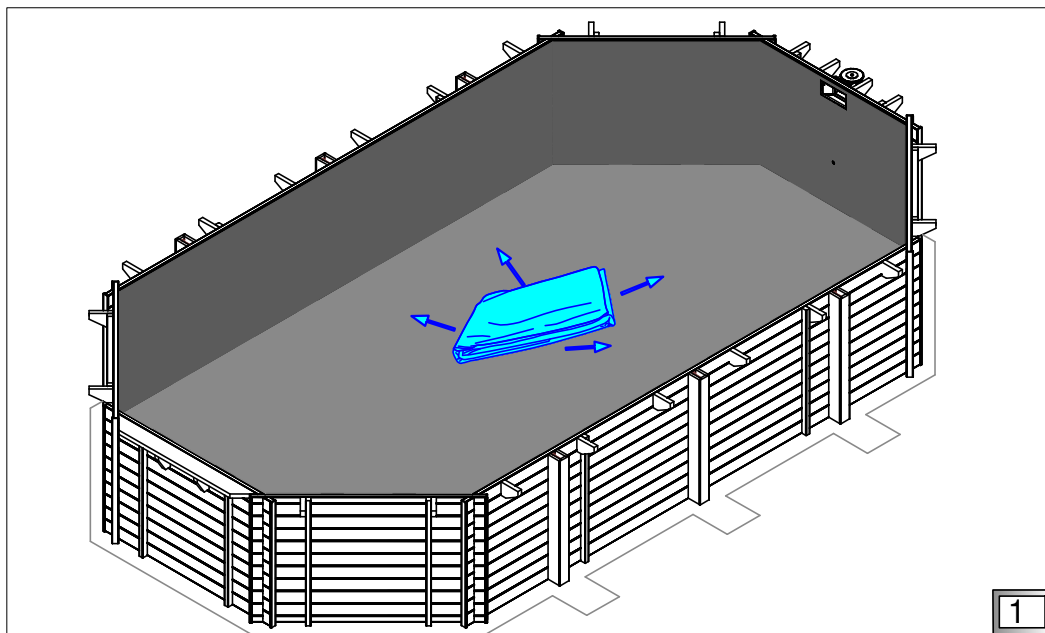
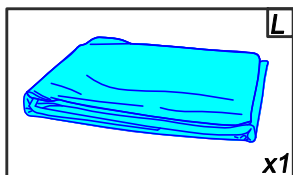

1

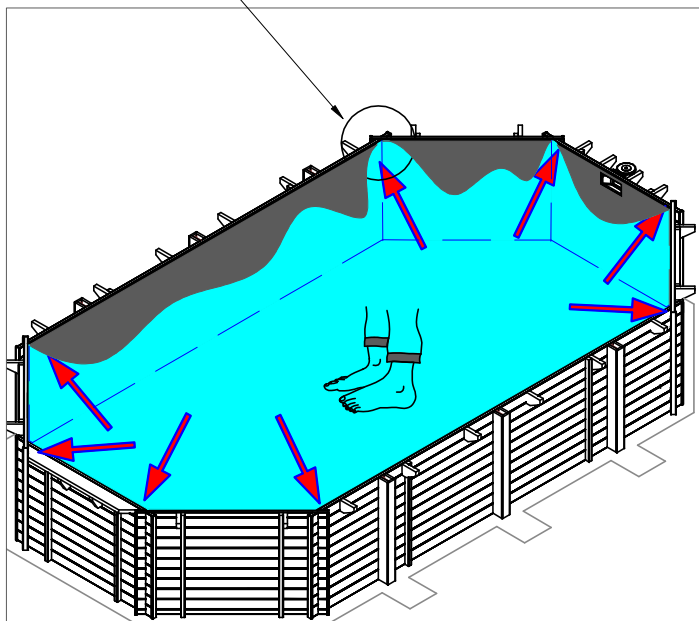
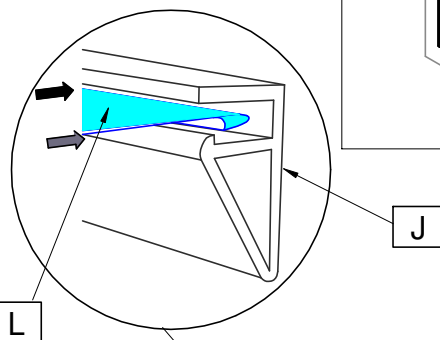

2

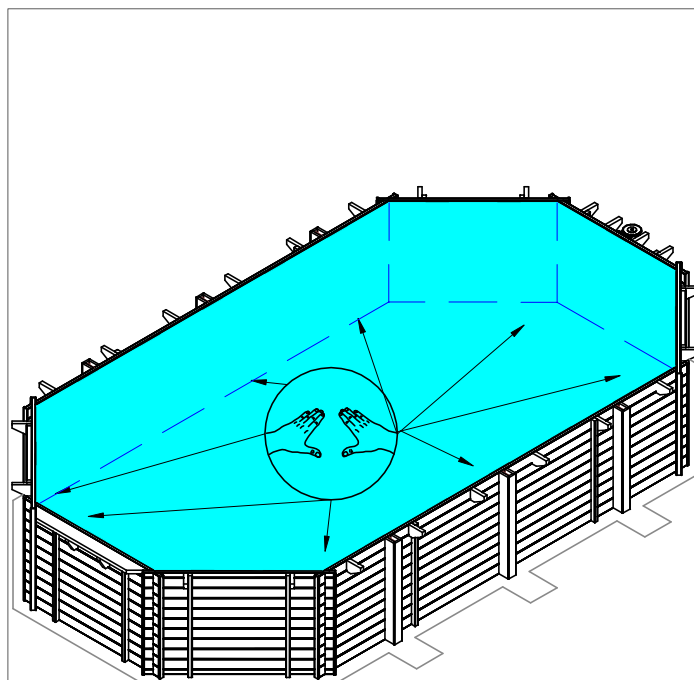

3

PL Liner

GB Liner

D Liner

FR Liner

IT Liner

NL Binnen bekleding



- PL** Montaż linera oraz stopera (M) w profilach PVC (J).
- FR** Le montage de la liner et de la bandelette (M) pour les profils d'accrochage (J).
- GB** Mounting the liner and liner lock (M) in PVC profiles (J).
- IT** Il montaggio di liner e tappo (M) in profili in PVC (J).
- D** Montage von Liner und von Stopper (M) in den PVC-Profilen (J).
- NL** Montage van de binnen bekleding (M) in de PVC profielen (J).

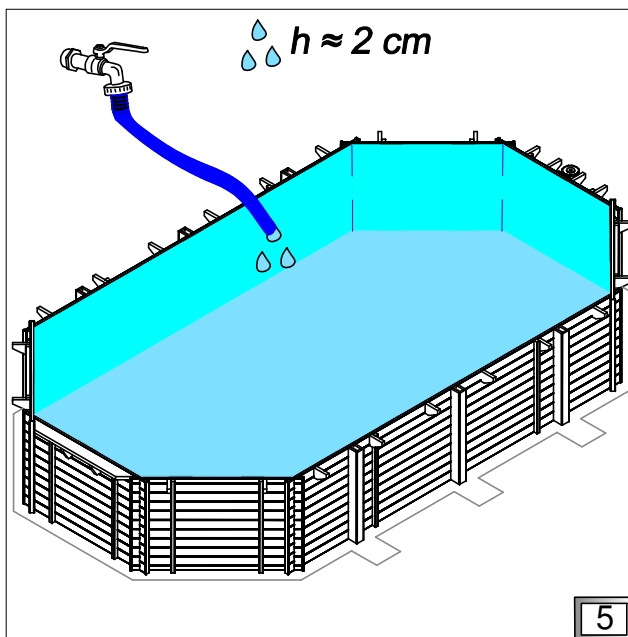
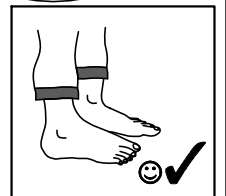
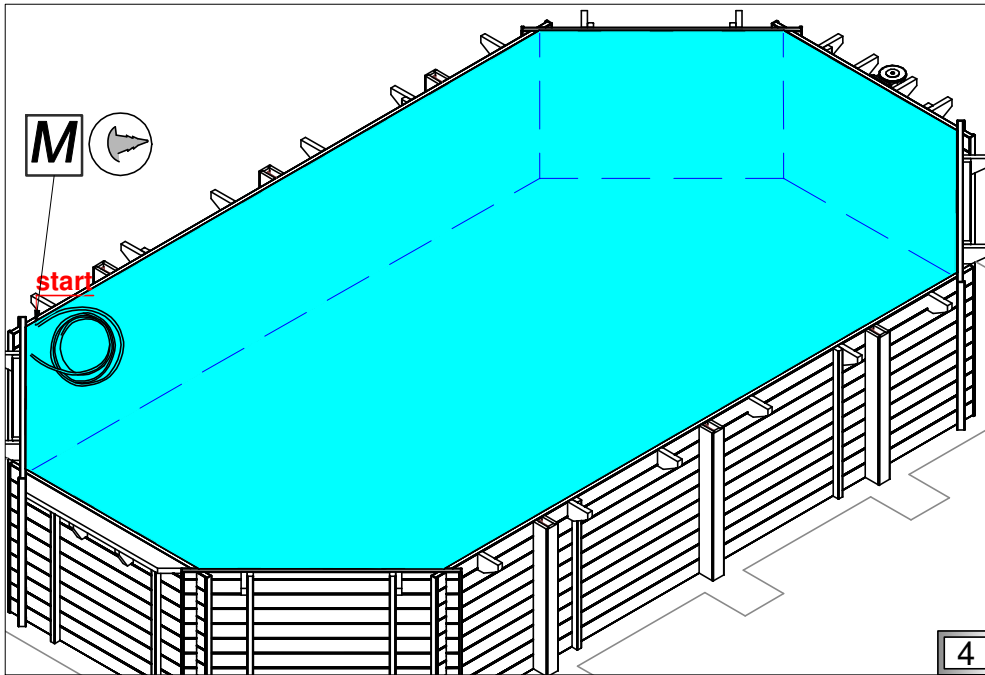
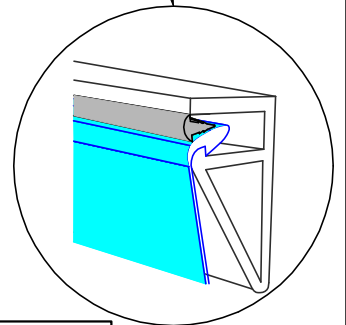
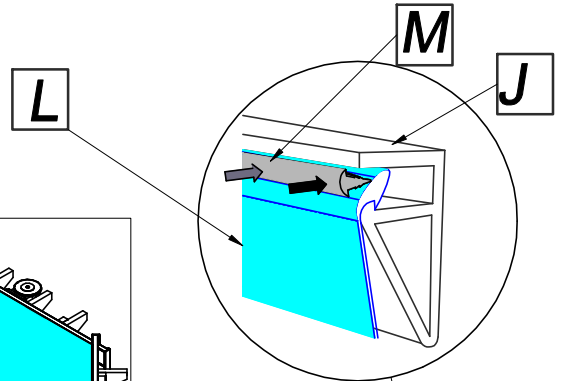
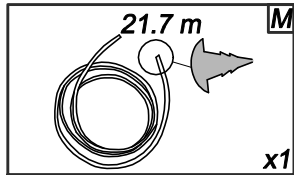
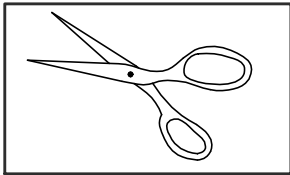

- PL** Wyrównaj sfałdowania po nalaniu wody.
- FR** Etalez les plis après avoir mis de l'eau.
- GB** Smooth all folds after pouring water.
- IT** Allineare le piegature dopo il versamento di acqua.
- D** Gleichen Sie Faltungen aus wenn das Wasser aufgegossen wurde.
- NL** Strijk alle plooien glad na het vullen van water.

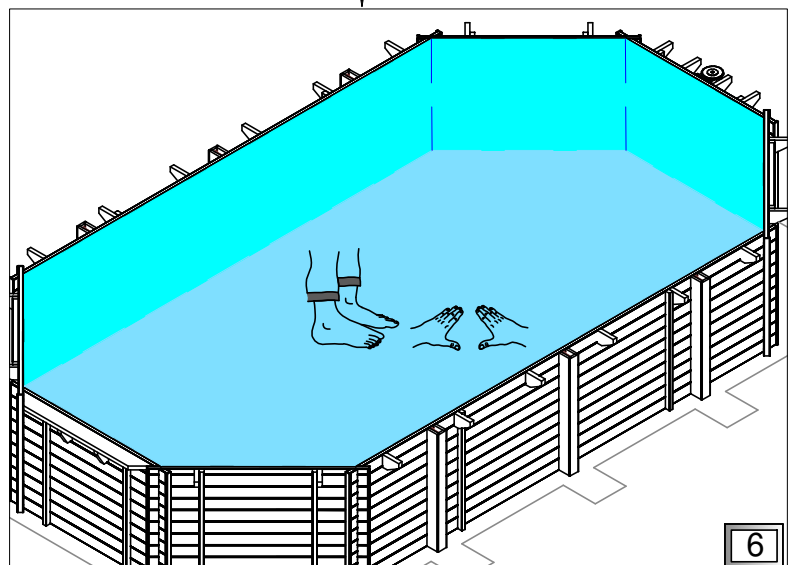

PL Dysze

GB Nozzles

D Düsen

FR Les buses de refoulement

IT Ugelli

NL Inlaat



PL Po kolejnym nalaniu wody wyrównać sfaldowania. Wytnij otwór pod dyszę.

FR Après le versement de l'eau éliminez les plis. Faites les trous à la buse de refoulement.

GB After pouring the water smooth all folds. Cut the hole for the nozzle.

IT Dopo un altro riempimento di acqua livellare le pieghe. Ritagliare i fori fino all'ugello.

D Nachdem Wasser wieder eingegossen wird, sind Faltungen zu ebnet. Öffnungen für die Düsen sind zu schneiden.

NL Na het gladstrijken van de plooien snij een gat voor de inlaat.

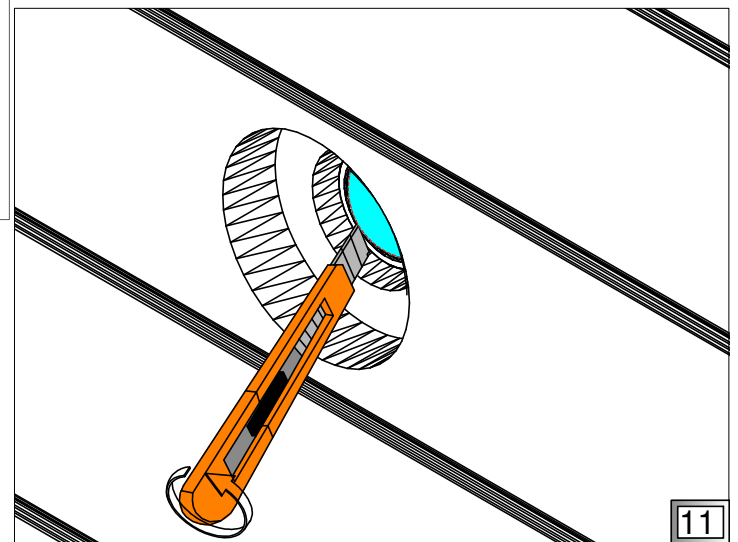
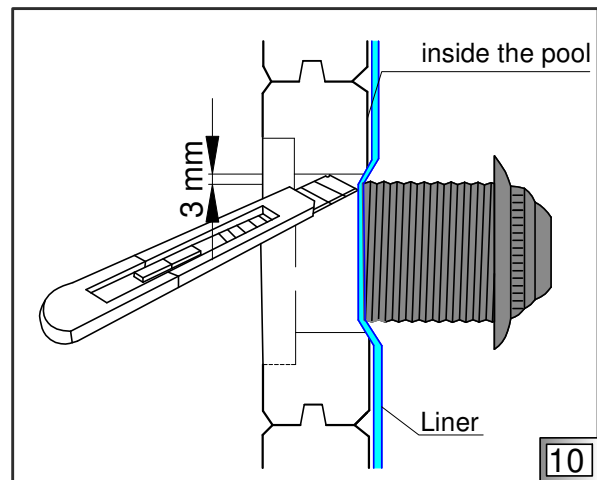
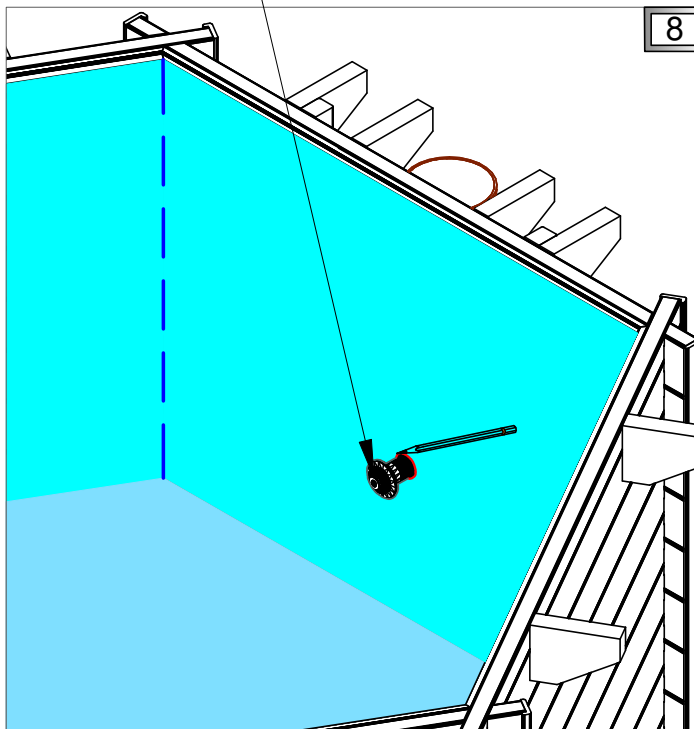
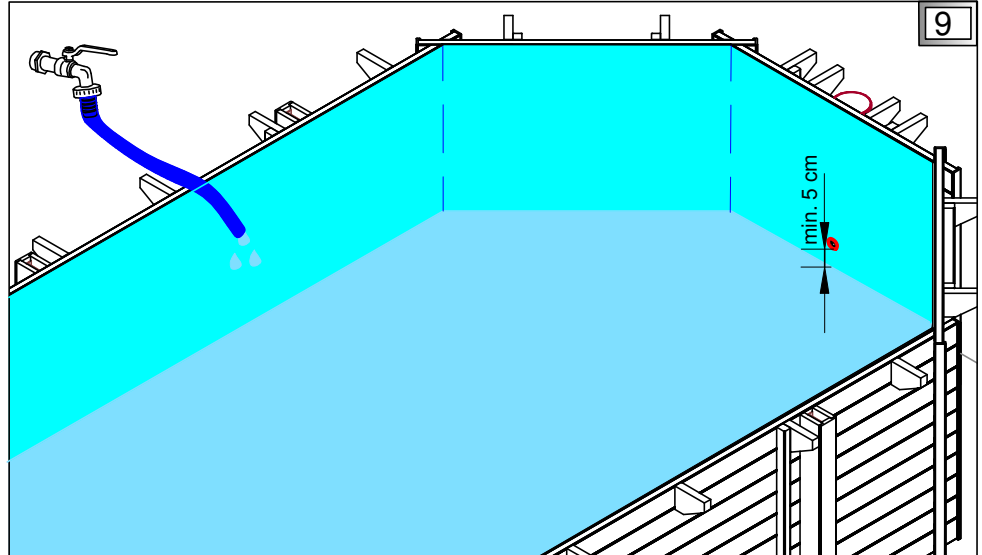
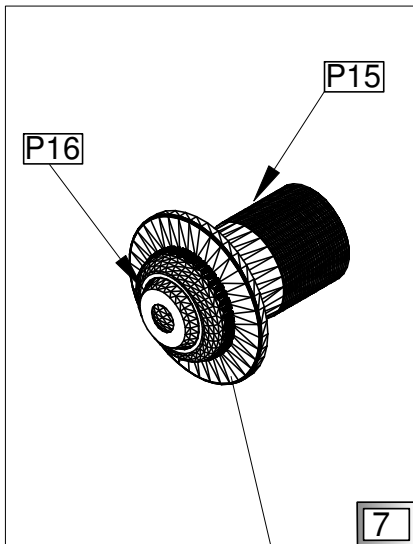
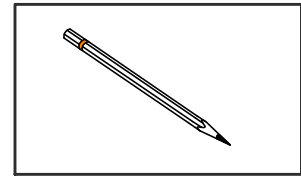
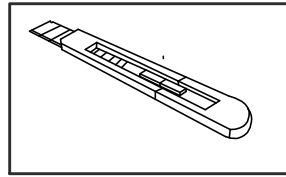
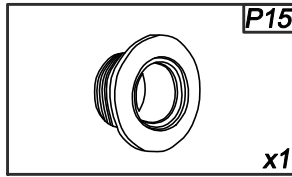
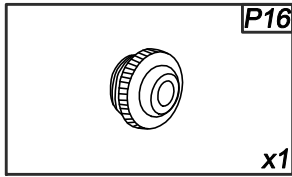

PL Dysze

GB Nozzles

D Düsen

FR Les buses de refoulement

IT Ugelli

NL Inlaat



PL Uszczelki (P13) posmarować wazeliną od strony linera. Mocowanie dysz.

FR Etalez de la vaseline sur les joints (P13) du côté de la liner. Le montage de la buse de refoulement.

GB Smear liner facing side of the gasket (P13) with vaseline. Installation of nozzles.

IT Sui sigilli (P13) da parte di liner mettere la vaselina. Fissaggio dei ugelli.

D Die Dichtungen (P13) sind von der Seite der Liner mit der Vaseline zu schmieren. Befestigung von Düsen.

NL Smeer de pakking (P13) in met vaseline. Installatie van de inlaat.

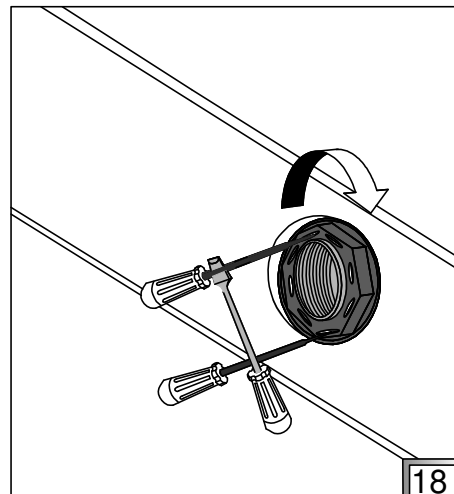
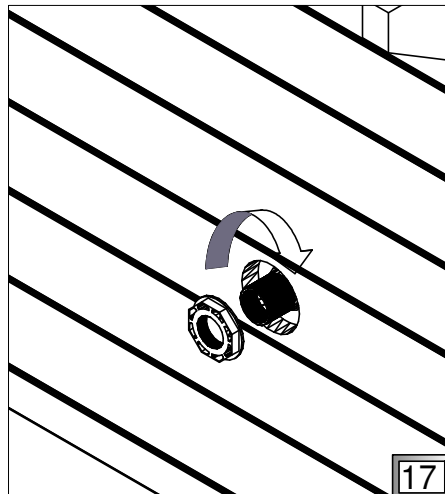
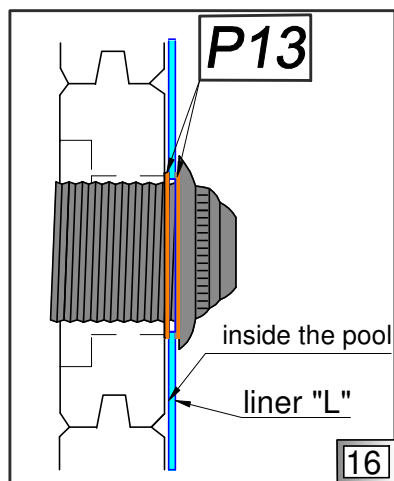
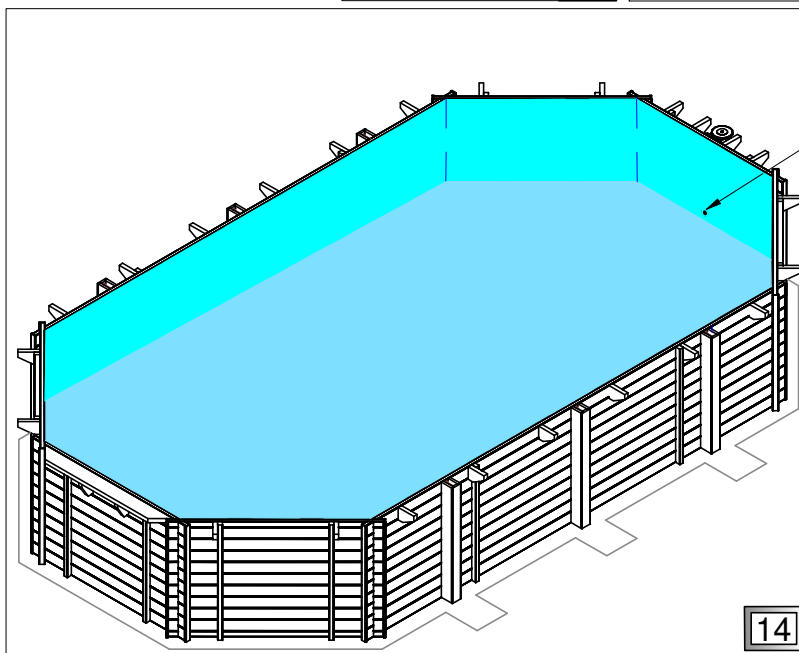
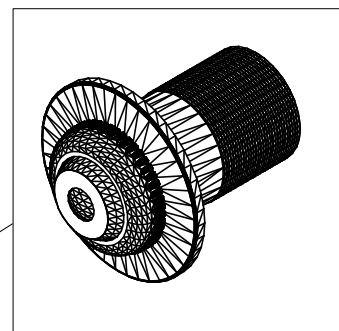
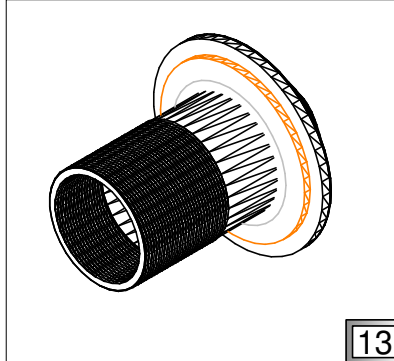
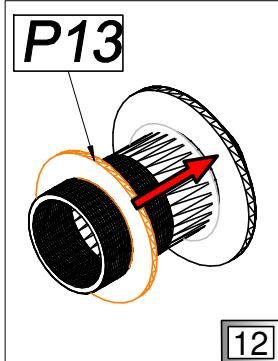
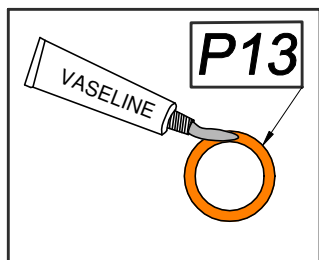
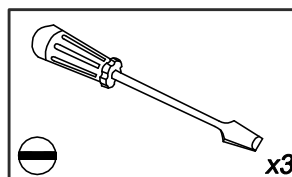
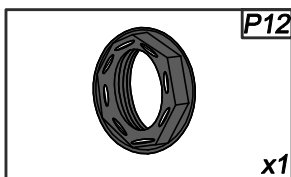
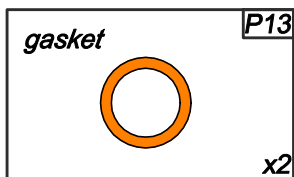

PL Dysze

GB Nozzles

D Düsen

FR Les buses de refoulement

IT Ugelli

NL Inlaat



PL Pokryj gwint dysz taśmą teflonową.

FR Mettez le ruban teflon sur la partie filetée de la buse.

GB Cover thread of hose connector with teflon tape.

IT Ricoprire il filetto degli ugelli con il nastro di teflon.

D Bedecken Sie die Düsengewinde mit dem Teflonband.

NL Wikkel de schroefdraad van de slangaansluiting in met Teflon tape.

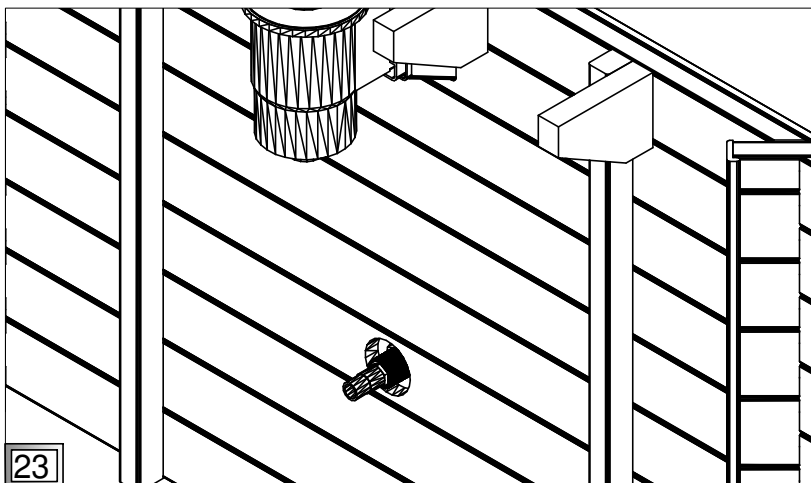
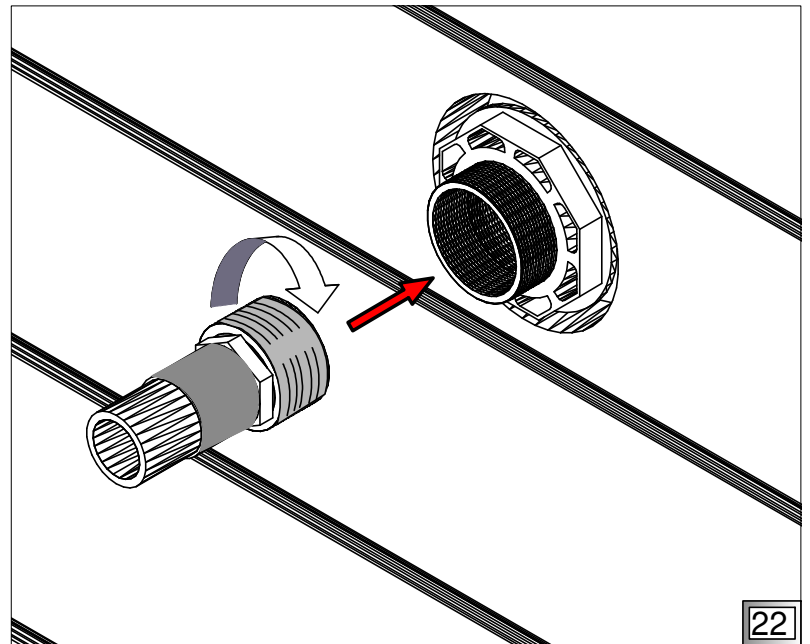
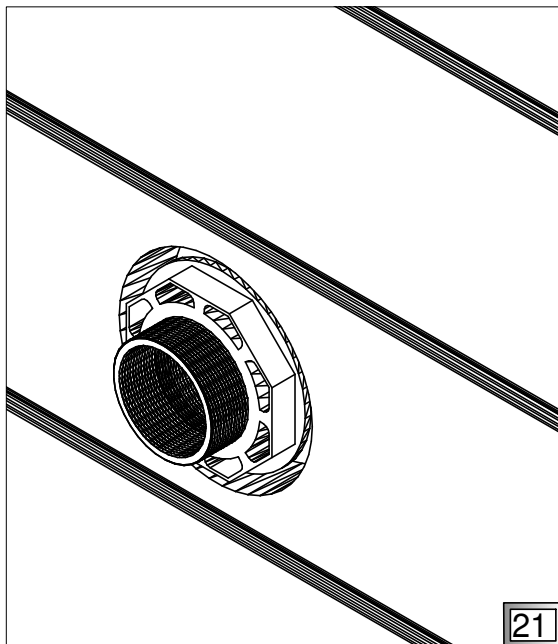
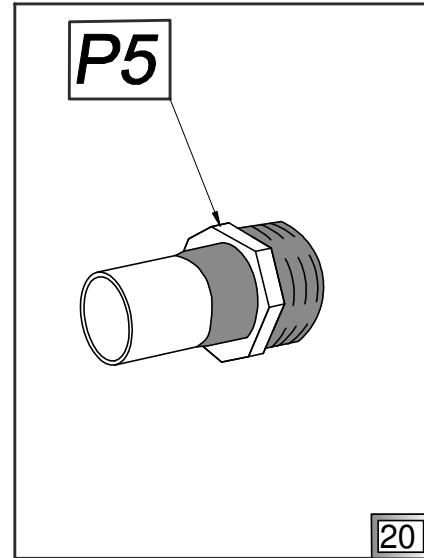
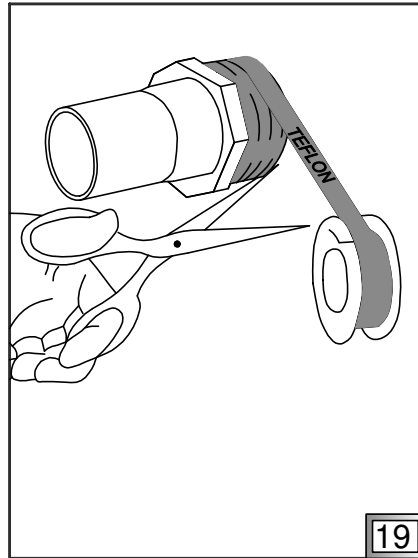
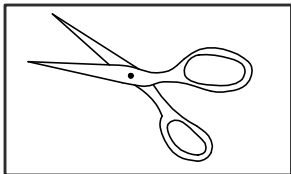
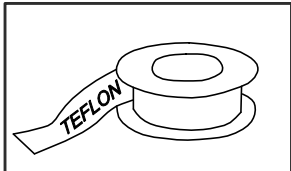
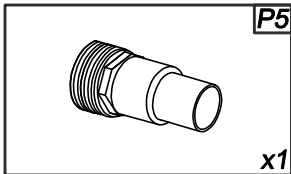

(PL) Napełnianie wodą

(GB) Filling with water

(D) Füllung mit Wasser

(FR) Le versement de l'eau

(IT) Riempimento con acqua

(NL) Vullen met water



(PL) Kontynuuj napełnianie wodą. Wytnij otwór w miejscu skimmera (P).

(FR) Continuez à mettre de l'eau. Coupez un trou pour le skimmer (P).

(GB) Keep pouring water. Cut a hole in the place of skimmer (P).

(IT) Continuare a riempire con acqua. Tagliare il foro nel posto dello skimmer (P).

(D) Setzen Sie das Füllen mit Wasser fort. Schneiden Sie eine Öffnung in der Stelle vom Skimmer (P) aus.

(NL) Vul verder met water. Maak een gat op de plaats van de skimmer (P).

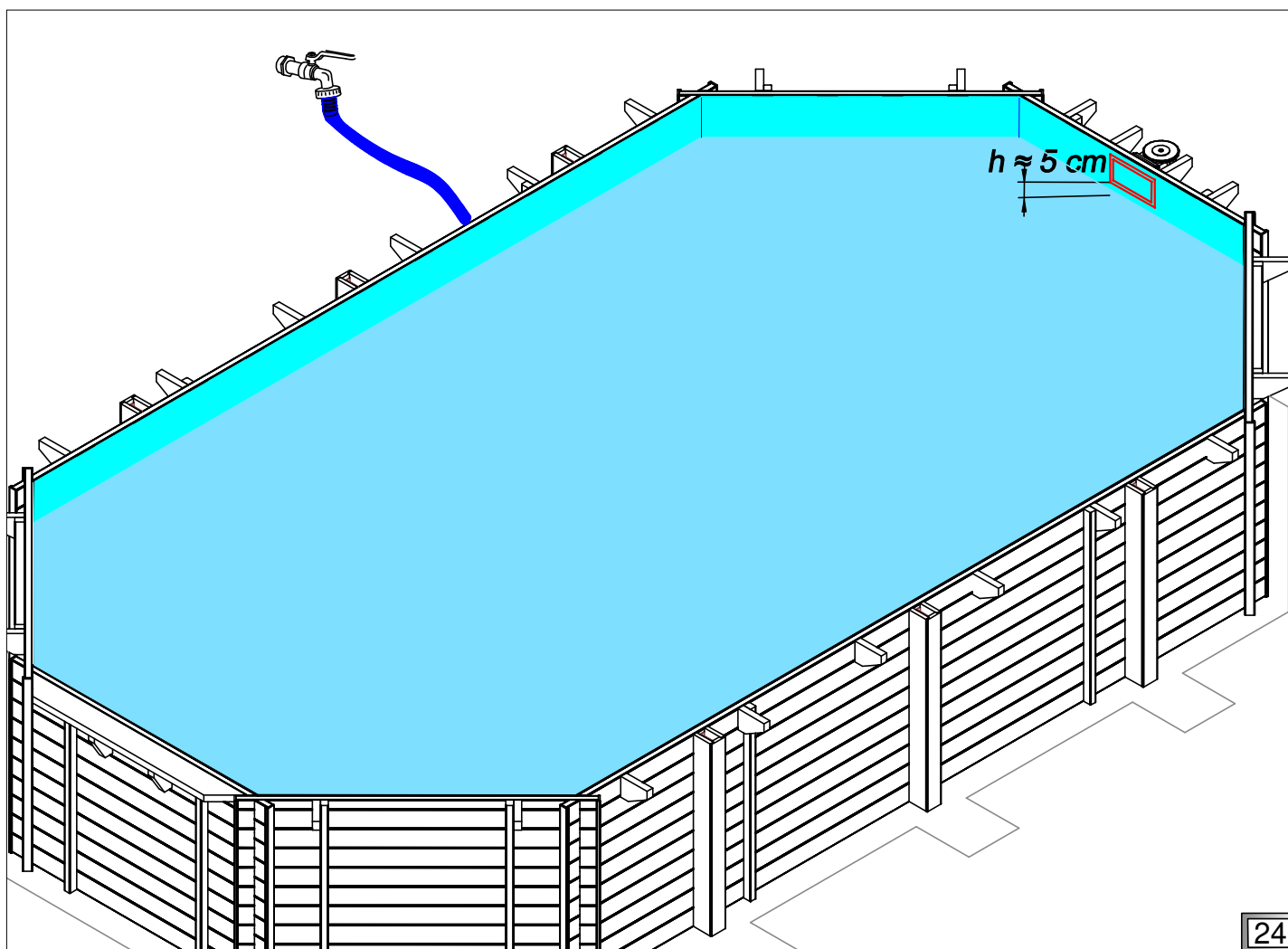
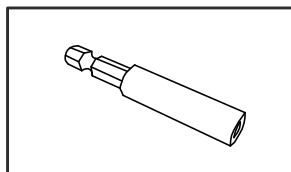
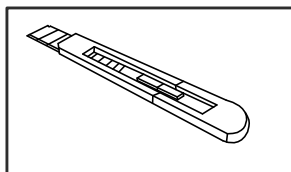
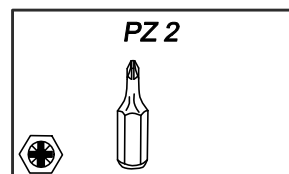
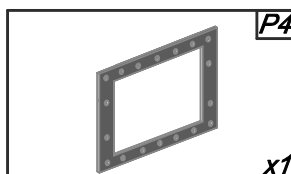
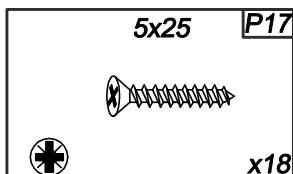
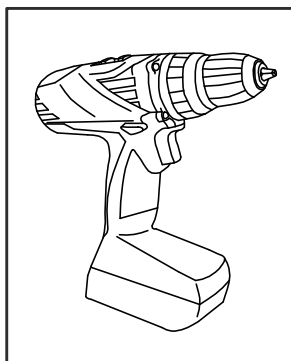

24

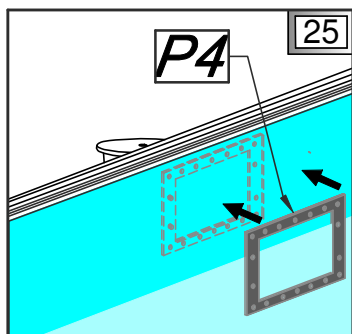

25

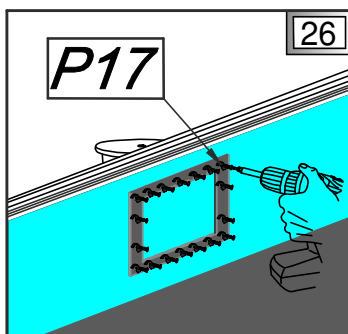

26

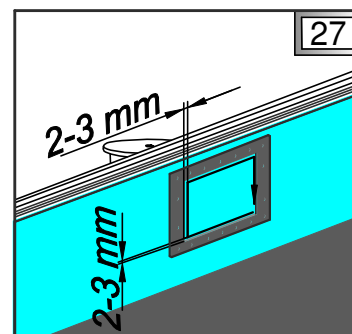

27

(PL) Napelnianie wodą

(GB) Filling with water

(D) Füllung mit Wasser

(FR) Le versement de l'eau

(IT) Riempimento con acqua

(NL) Vullen met water



(PL) Usunąć ramkę (P4). Zamocuj uszczelkę (P3), ramkę (P4), maskownicę (P4a).

(FR) Enlevez le cadre (P4). Fixez le joint (P3), le cadre (P4), le cache (P4a).

(GB) Remove a frame (P4). Install gasket (P3), frame (P4) and masking frame (P4a).

(IT) Rimuovere la cornice (P4). Montare la guarnizione (P3), la cornice (P4), mascherino (P4a).

(D) Entfernen Sie den Rahmen (P4). Legen Sie die Dichtung (P3), der Rahmen (P4), Maske (P4a).

(NL) Verwijder de frame (P4) installeer de pakking (P3) monteer de frame (P4) en bedek af met (P4a).

Gasket

P3

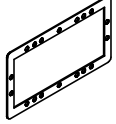

x1

P4

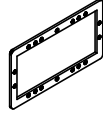

x1

P4a

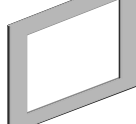

x1



x1

28

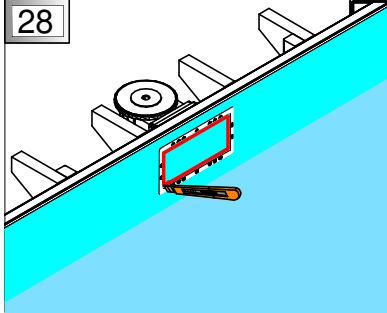

29

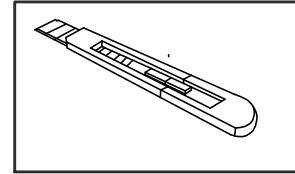
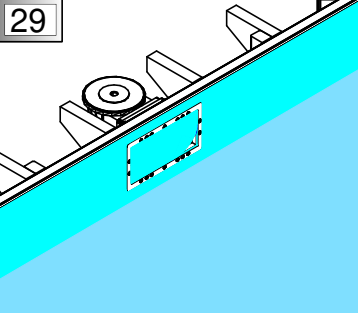

30

P4

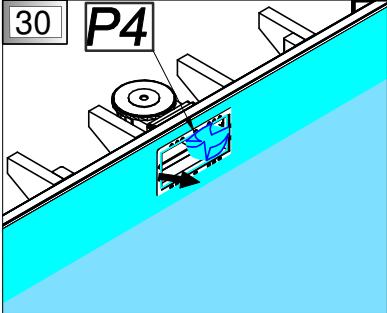

31

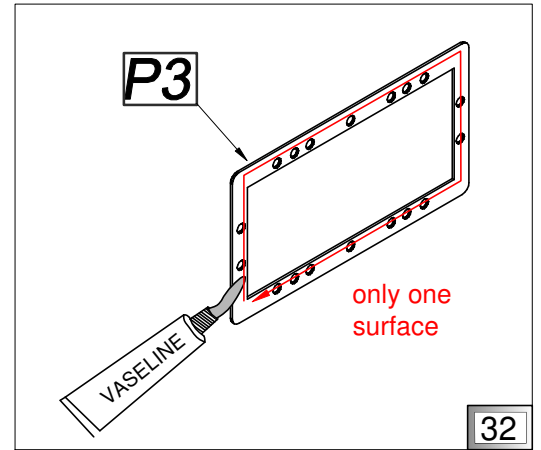
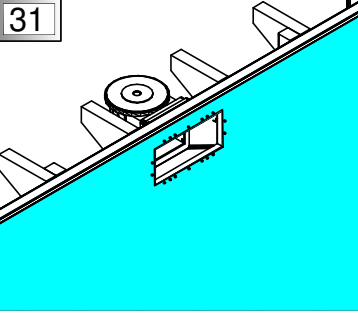

32

33

P3

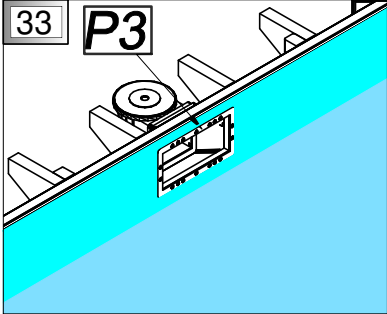

34

P17

P4

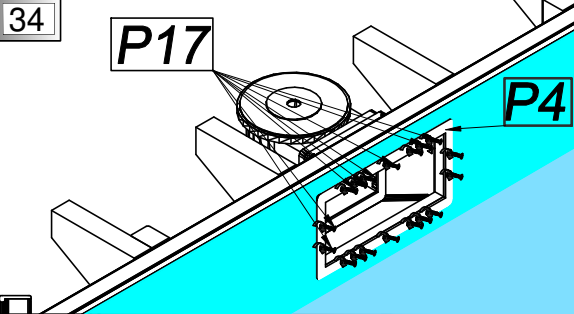

35

P4a

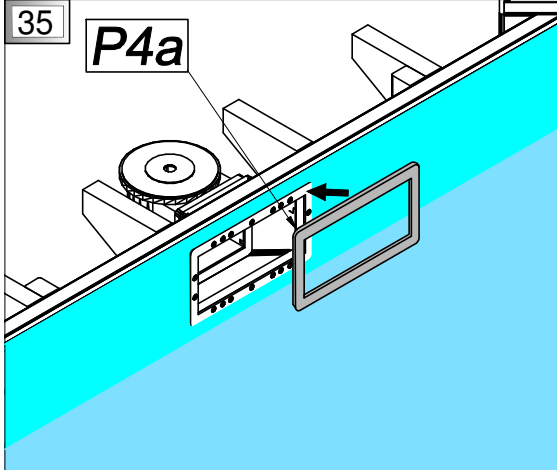

36

clik!

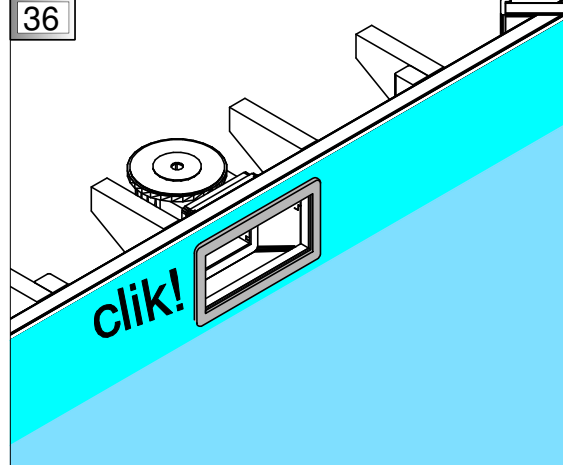

PL Napełnianie wodą

GB Filling with water

D Füllung mit Wasser

FR Le versement de l'eau

IT Riempimento con acqua

NL Vullen met water



PL Napełnij wodą do połowy wysokości maskownicy.

FR Versez de l'eau à la mi-hauteur du cadre skimmer.

GB Fill with water to the middle of the masking element.

IT Riempire con acqua a metà dell'altezza del mascherino.

D Die Hälfte von der Abdeckung ist an die Hälfte zu füllen.

NL Vul het water tot het midden van de skimmer.

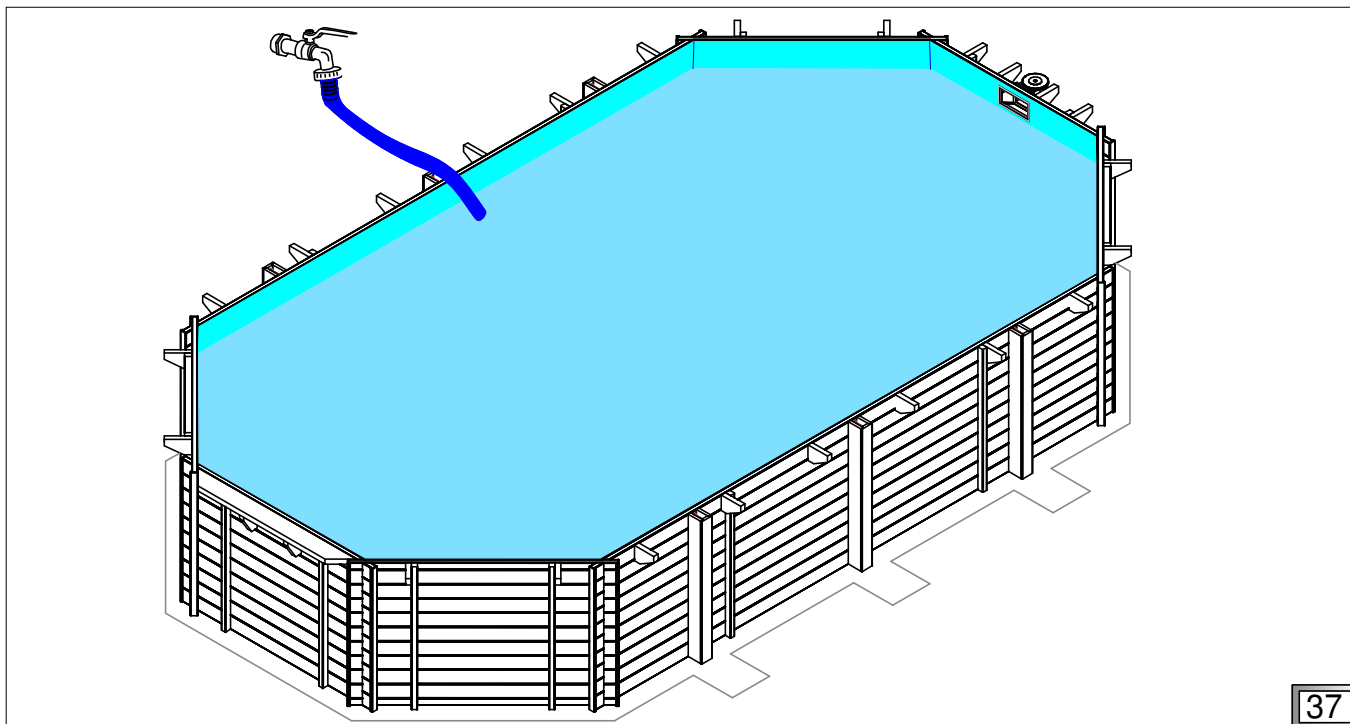

37

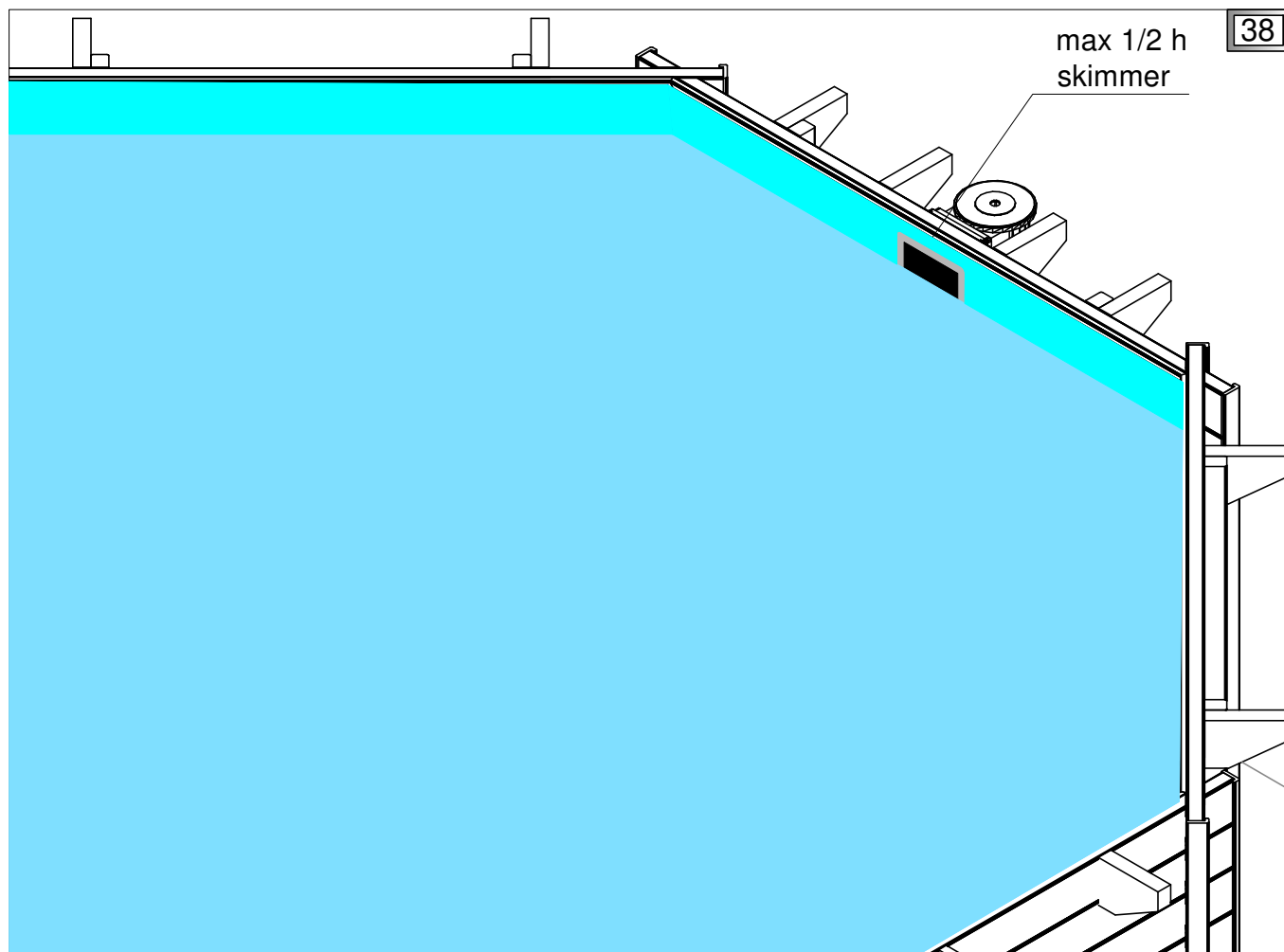

38

PL Taras

GB Terrace

D Terrasse

FR Les margelles

IT Terrazza

NL Bovenrand



- PL** Montaż desek tarasowych.
- FR** Le montage des margelles.
- GB** Installation of terrace boards.
- IT** Installazione delle tavole da terrazza.
- D** Montage vom Terrassenholz.
- NL** Installatie van de bovenrand.

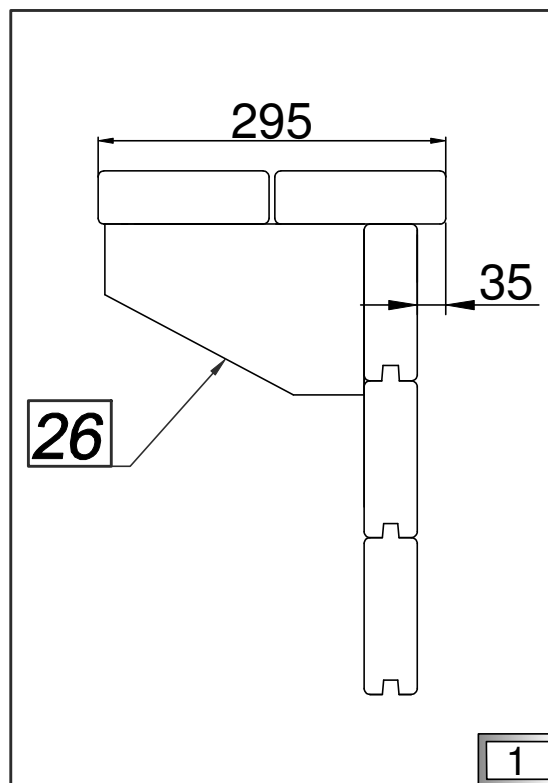
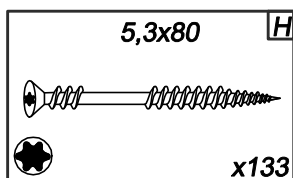
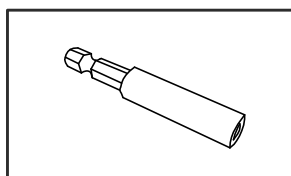
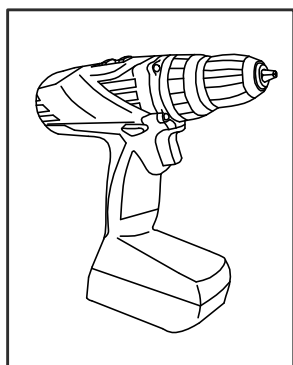
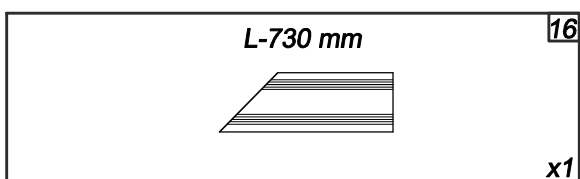
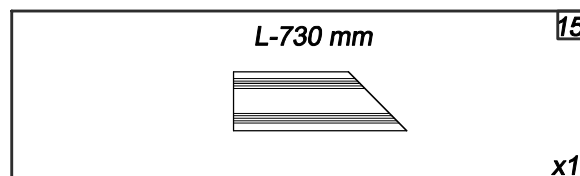
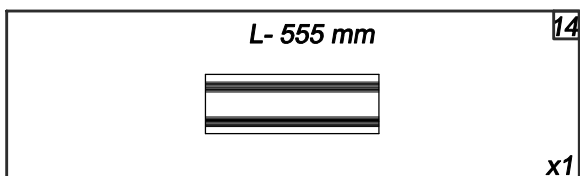
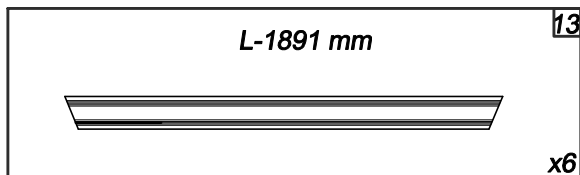
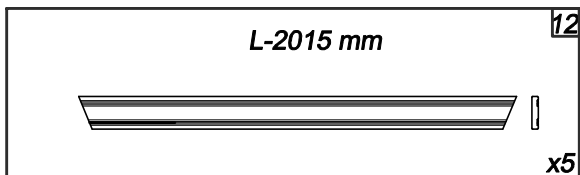
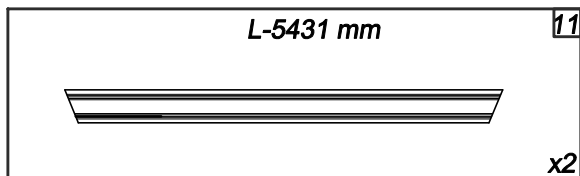
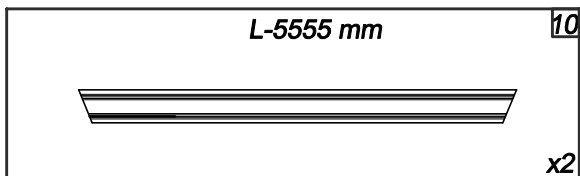

PL Taras

GB Terrace

D Terrasse

FR Les margelles

IT Terrazza

NL Bovenrand



PL Zamocuj deski tarsowe według rysunku 2;3.

FR Faites monter les margelles suivant le dessin 2;3.

GB Mount terrace boards according to the drawing 2;3.

IT Montare le tavole da terrazza secondo il disegno 2;3.

D Befestigen Sie das Terrassenholz nach der Abbildung 2;3.

NL Monteer de bovenrand volgens tekening 2;3.

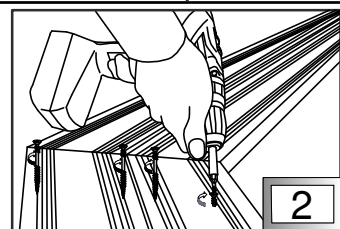

2

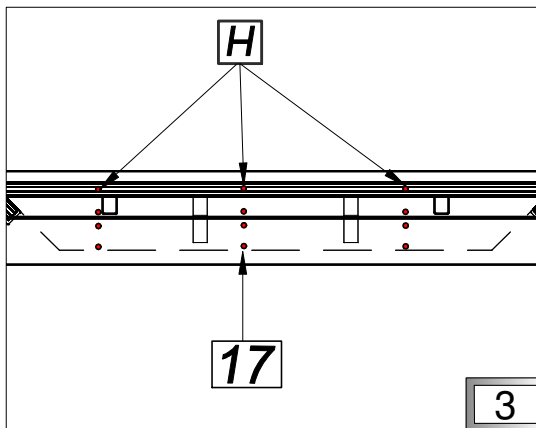
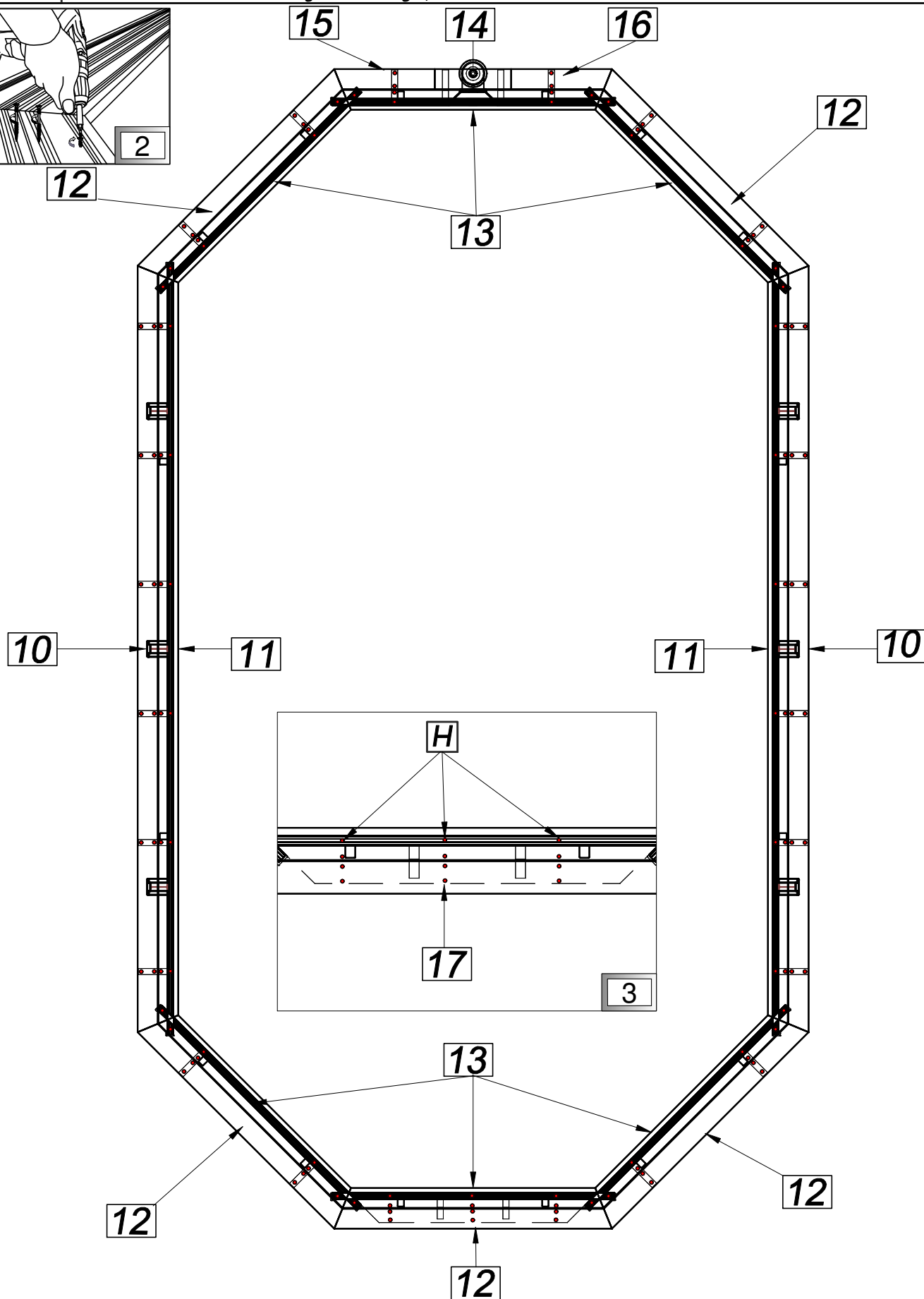

3

PL Zapięcie tarasu

GB Clip and hook

D Terrassenverschluss

FR Agraffes de margelles

IT Chiusura di terrazza

NL Klip en haak



PL Montaż zapięcia tarasu (A1, A2).

FR Le montage des agraffes de margelles (A1, A2).

GB Mounting clip and hook (A1, A2).

IT Montaggio della chiusura di terrazza (A1, A2).

D Montage vom Terrassenverschluss (A1, A2).

NL Installatie van de klip en haak voor de houten trap (A1, A2).

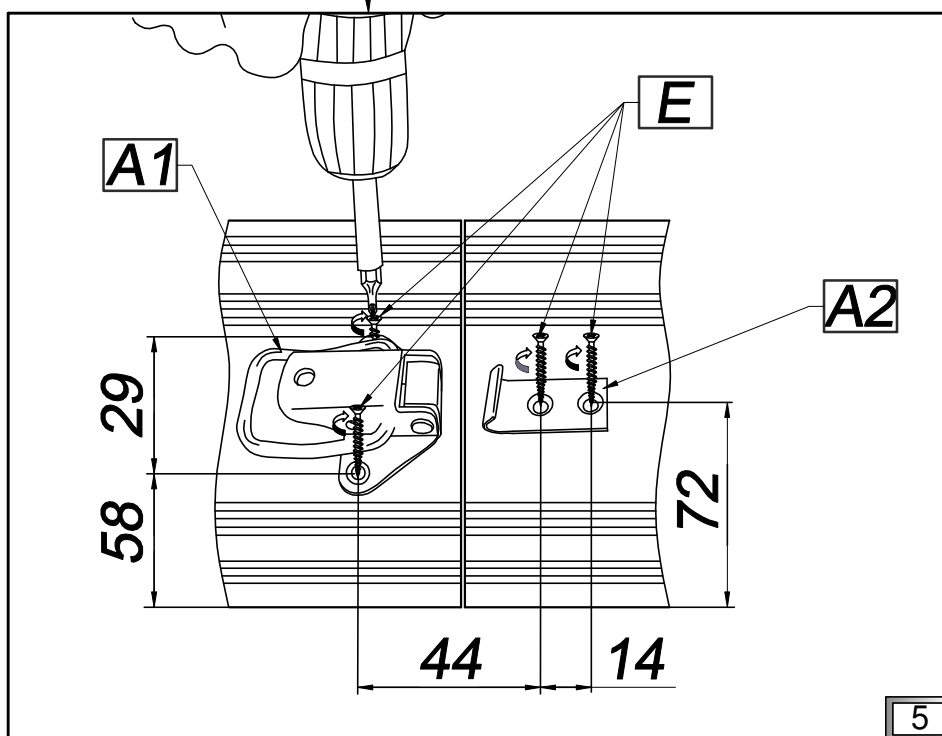
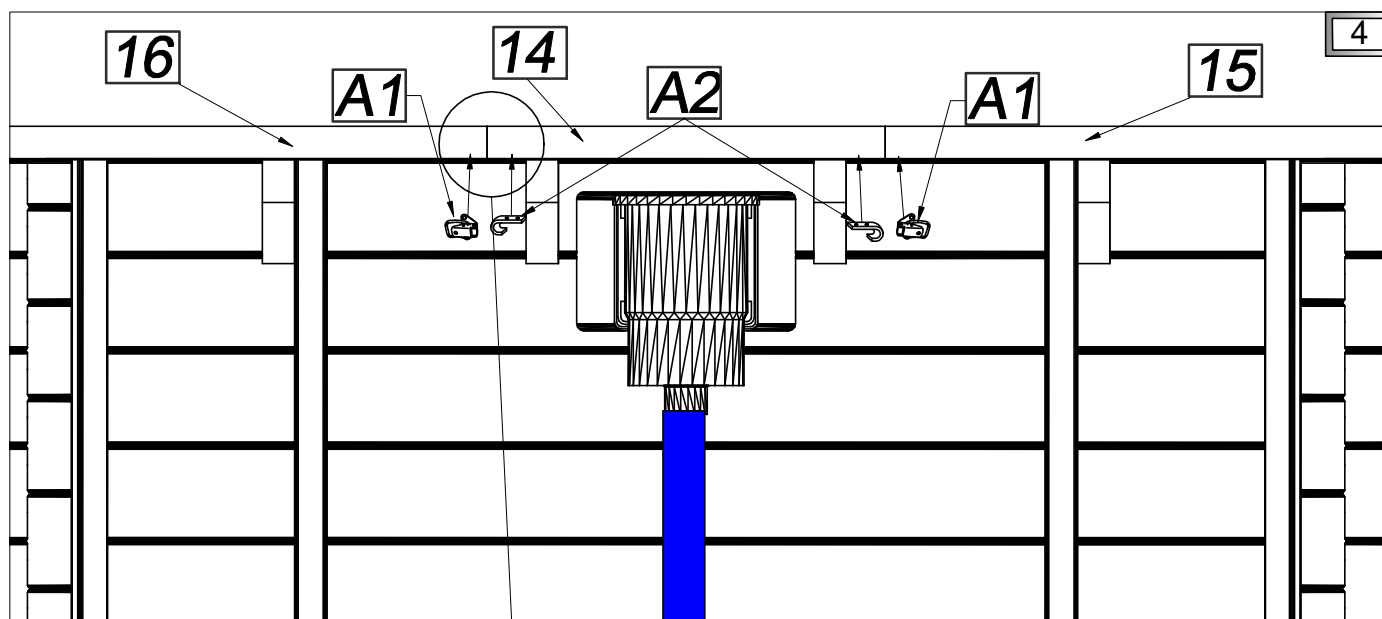
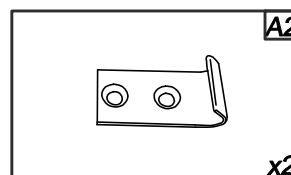
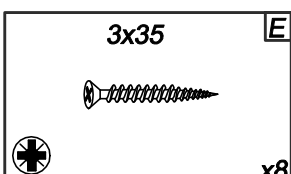
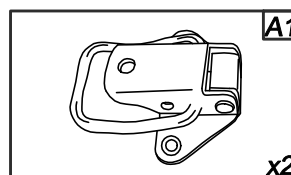
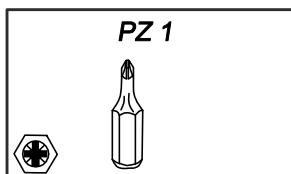
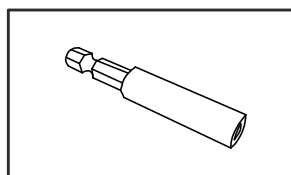
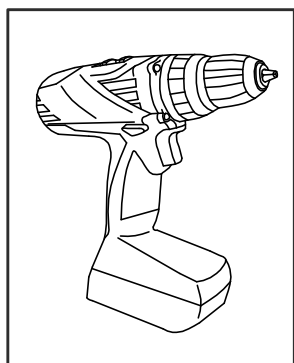

PL Struktura drewniana

GB Wooden structure

D Holzstruktur

FR La structure bois

IT Struttura in legno

NL Houten structuur



- PL** Montaż łącznika karo (27) od spodu desek tarasowych.
- FR** Le montage des jonctions (27) en dessous des margelles.
- GB** Installation of wooden connector (27) to the bottom of terrace boards.
- IT** Montaggio di raccordo (27) dal fondo delle tavole da terrazza.
- D** Montage vom Caro- Bindeglied (27) von der Unterseite des Terrassenholzes.
- NL** Installatie van de houten connector (27) aan de onderkant van de bovenranden.

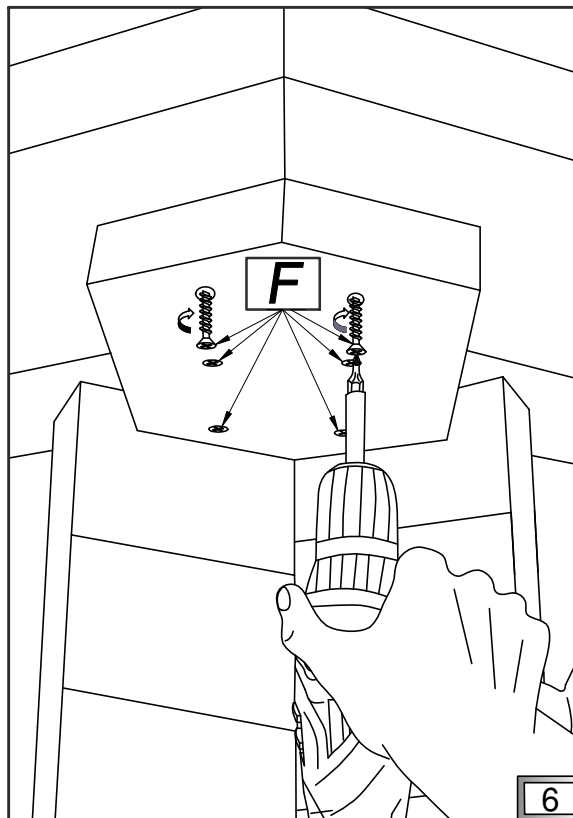
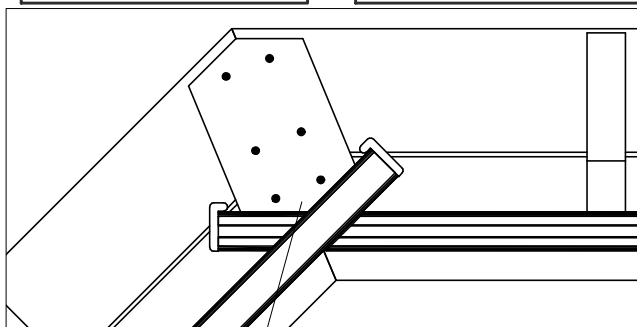
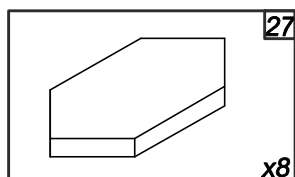
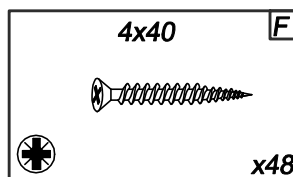
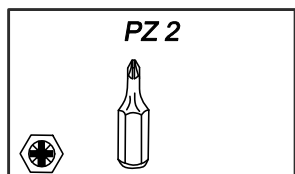
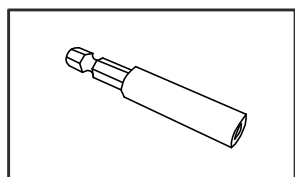
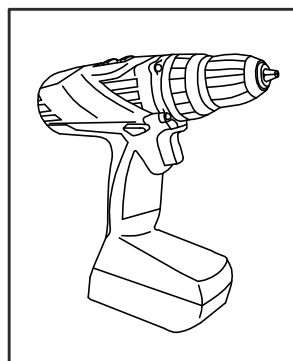

27

27

27

27

- PL** Widok od spodu tarasu.
- FR** La vue du dessous des margelles.
- GB** View from the bottom of terrace.
- IT** Vista in fondo della terrazza.
- D** Sicht vom unten der Terrasse.
- NL** Uitzicht van de onderkant van de bovenrand.

(PL) Schody drewniane

(GB) Wooden stairs

(D) Holztreppe

(FR) L'escalier bois

(IT) Scale di legno

(NL) Houten trap



(PL) Montaż schodów.

(FR) Le montage de l'escalier.

(GB) Installation of stairs.

(IT) Montaggio delle scale.

(D) Montage von Treppen.

(NL) Installatie van de houten trap.

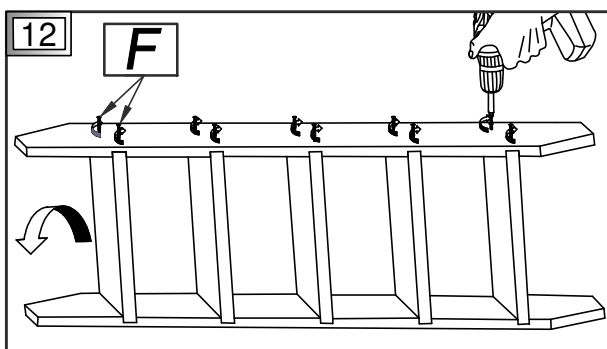
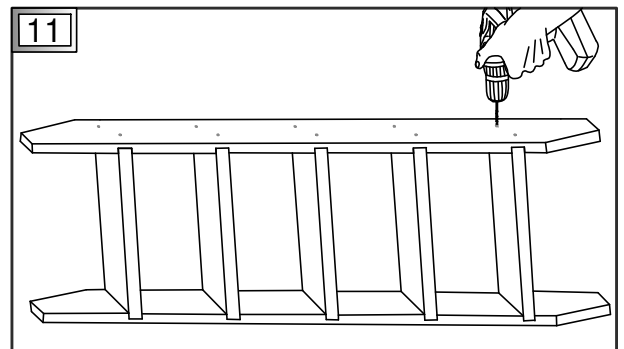
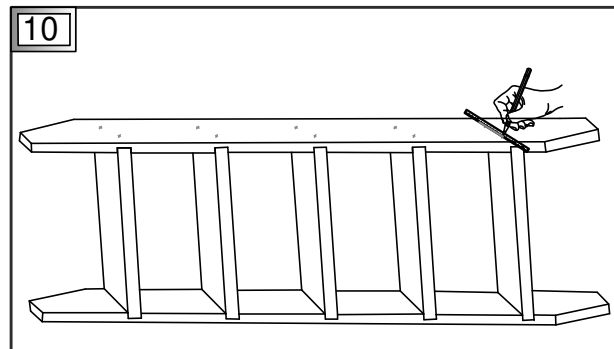
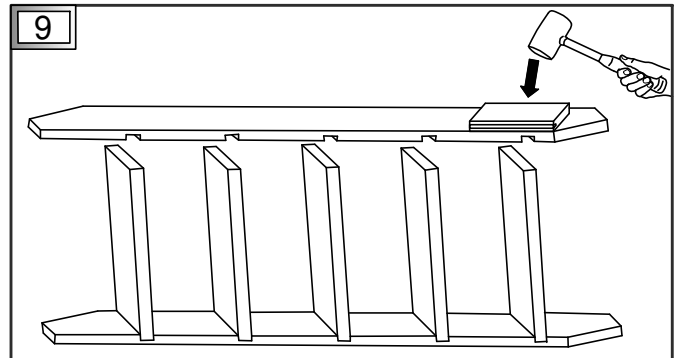
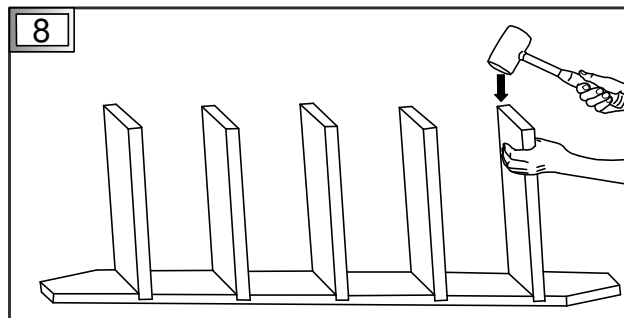
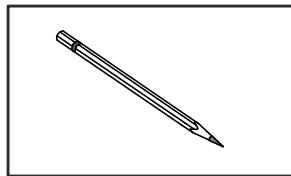
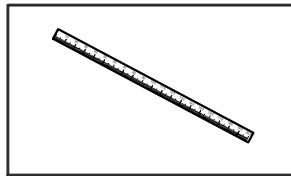
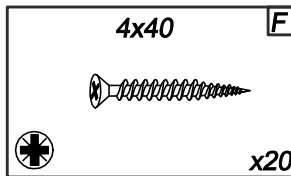
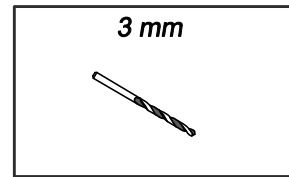
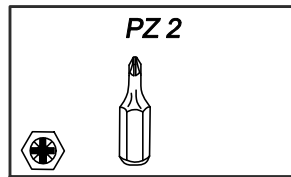
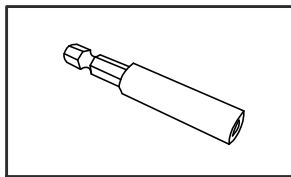
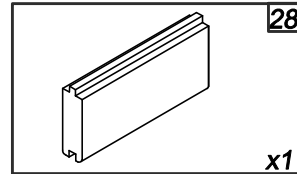
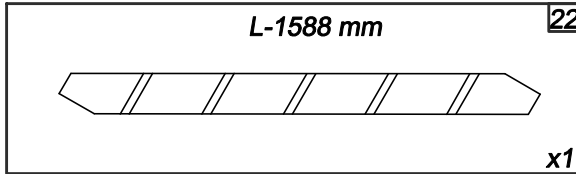
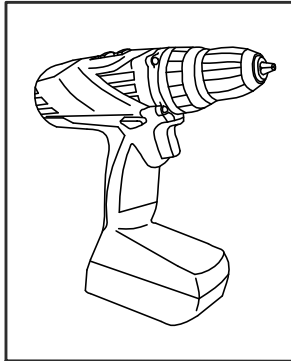
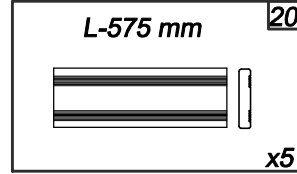
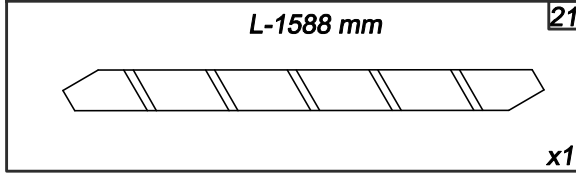
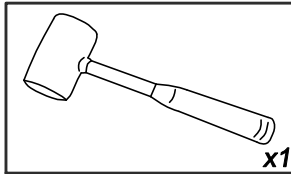

(PL) Schody drewniane

(GB) Wooden stairs

(D) Holzterppe

(FR) L'escalier bois

(IT) Scale di legno

(NL) Houten trap



(PL) Montaż zawieszki (B1, B2). Schody mocujemy na ścianie ze wspornikiem schodów (17).

(FR) Le montage des boucles et des gâches (B1, B2). Fixez l'escalier sur la paroi avec le renfort d'escalier (17).

(GB) Installation of tag and hook kit (B1, B2). Stairs are mounted on the wall with stairs support (17).

(IT) Montaggio del manico (B1, B2). Le scale sono fissate al muro con uno sbalzo di scale (17).

(D) Montage vom Gehänge (B1, B2). Die Treppe ist an die Wand mit Treppenstützen (17) zu montieren.

(NL) Installatie van het inhaak systeem (B1, B2). Trap wordt aan de bovenrand gemonteerd (17).

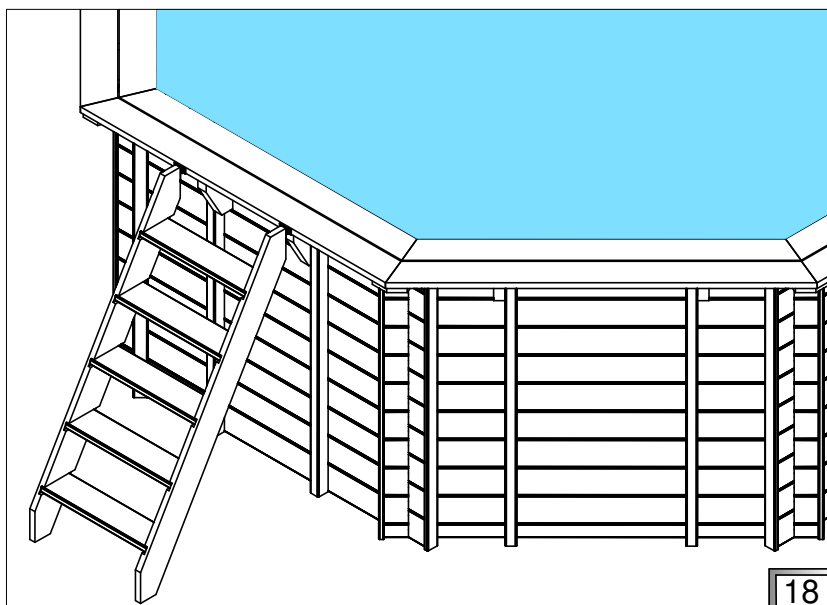
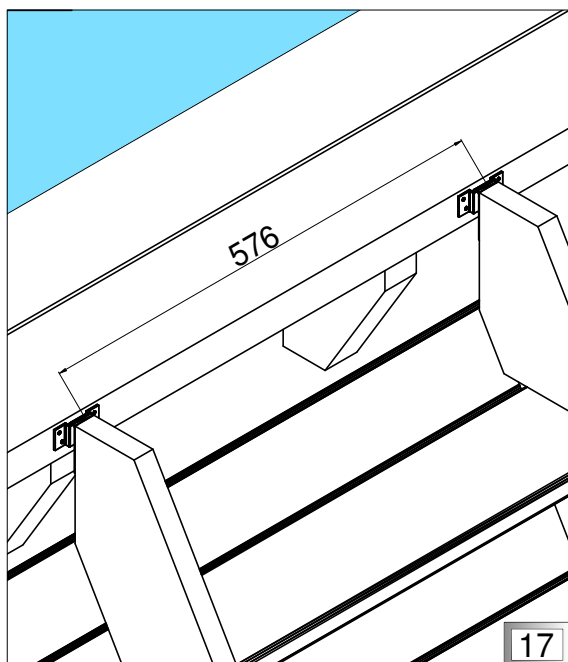
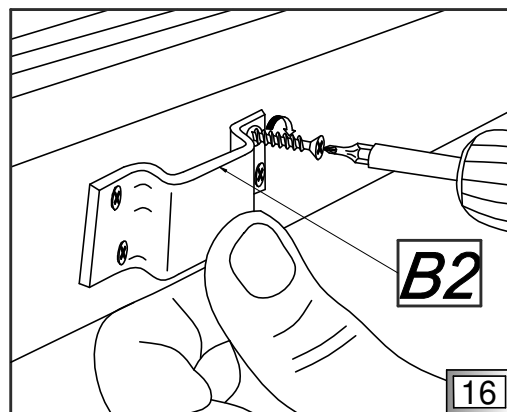
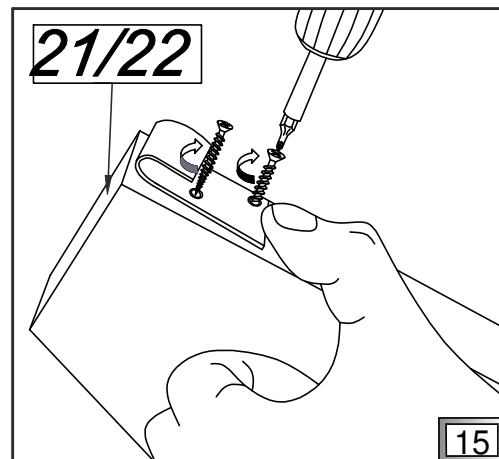
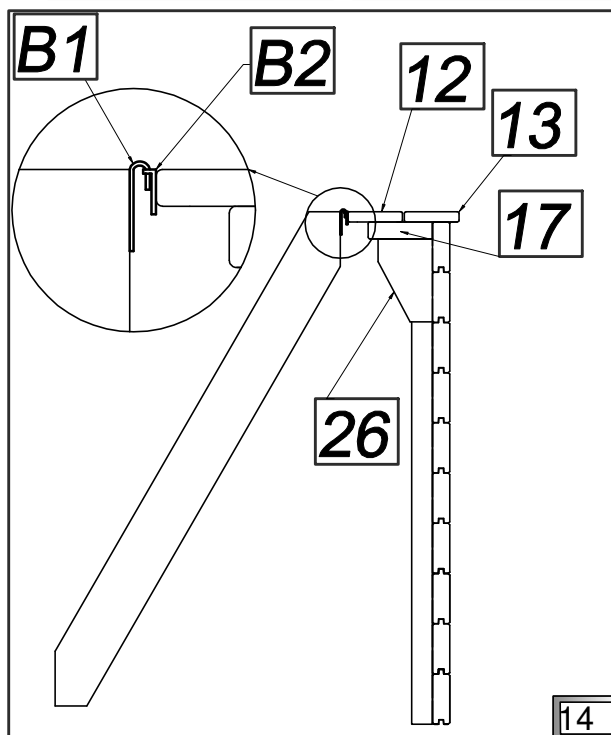
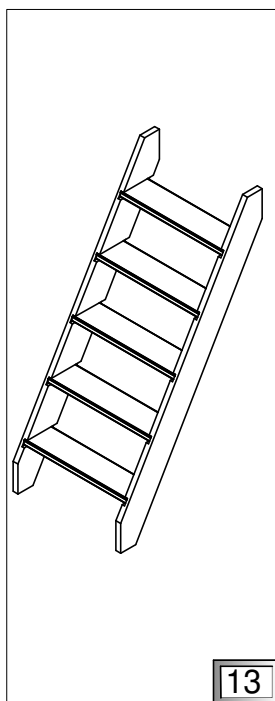
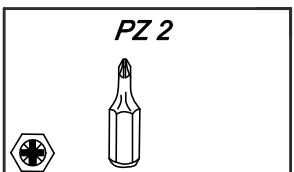
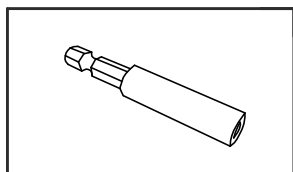
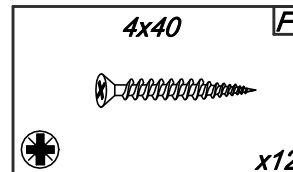
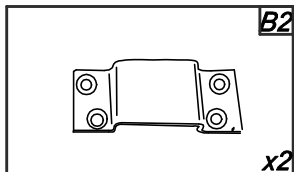
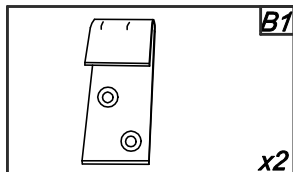
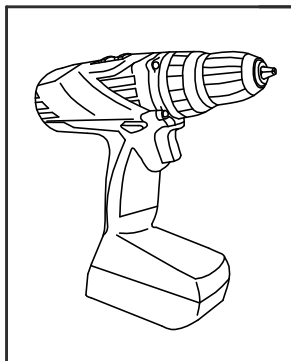

PL Drabinka stalowa

GB Stainless steel ladder

D Metallleiter

FR L'échelle inox

IT Scaletta in acciaio

NL Roestvrij stalen ladder



PL Montaż stalowej drabinki wewnętrznej do desek tarasowych.

FR La fixation de l'échelle inox aux margelles.

GB Mounting stainless steel ladder to the terrace boards.

IT Montaggio della scala interna alle tavole da terrazza.

D Montage von der Innenleiter aus Stahl ans Terrassenholz.

NL Installation of stainless steel ladder.

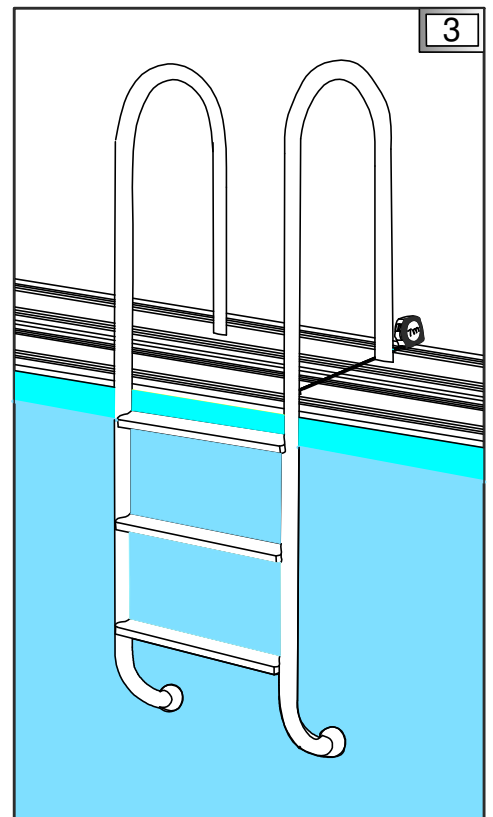
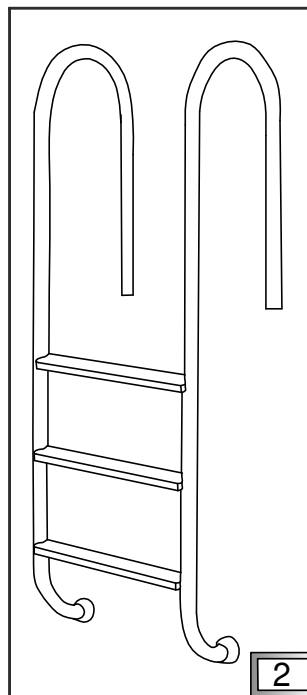
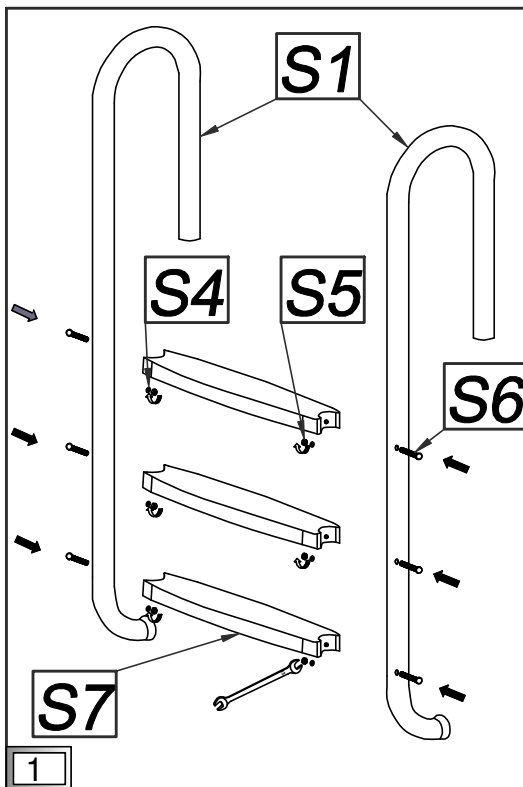
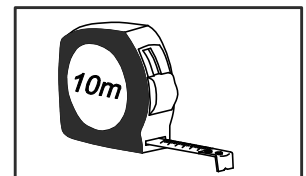
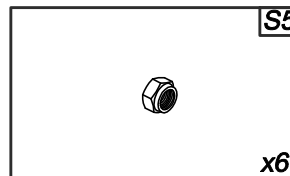
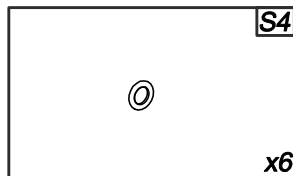
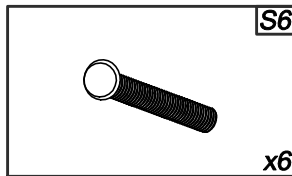
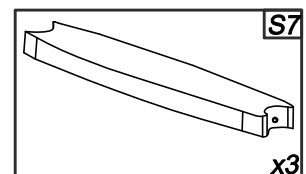
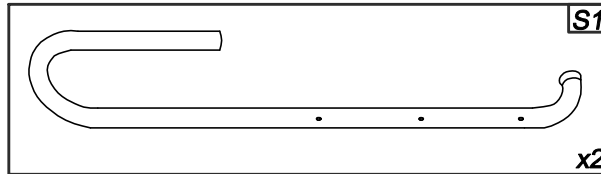
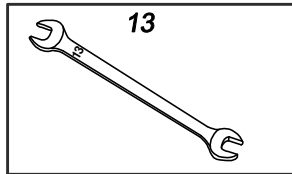

PL Drabinka stalowa

GB Stainless steel ladder

D Metallleiter

FR L'échelle inox

IT Scaletta in acciaio

NL Roestvrij stalen ladder



PL Montaż stalowej drabinki wewnętrznej do desek tarasowych.

FR La fixation de l'échelle inox aux margelles.

GB Mounting stainless steel ladder to the terrace boards.

IT Montaggio della scala interna alle tavole da terrazza.

D Montage von der Innenleiter aus Stahl ans Terrassenholz.

NL Montage roestvrij stalen ladder op de terras planken

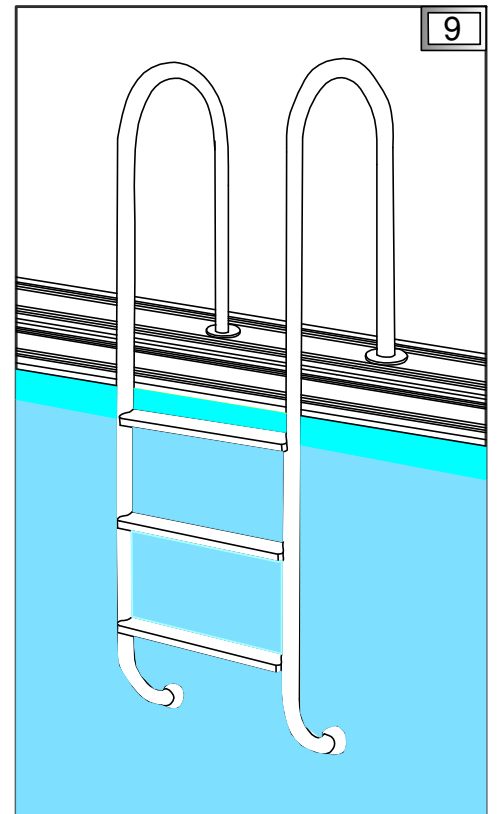
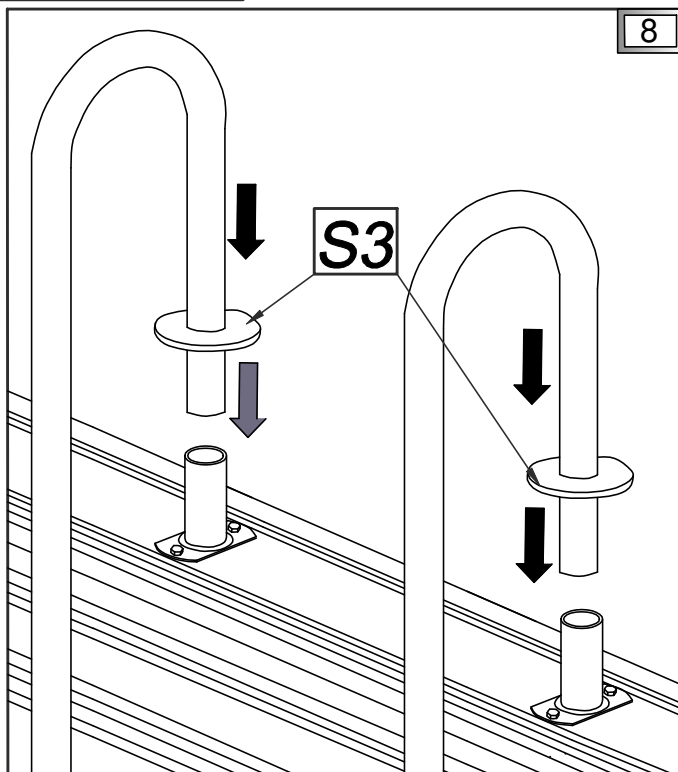
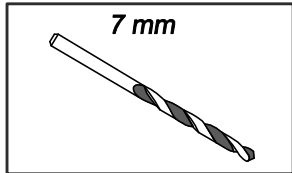
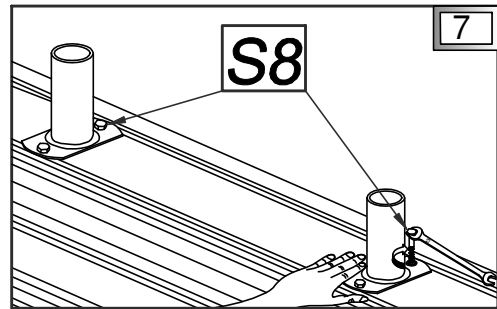
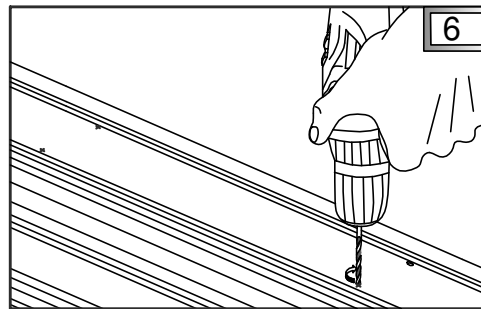
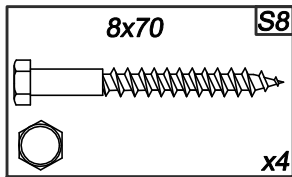
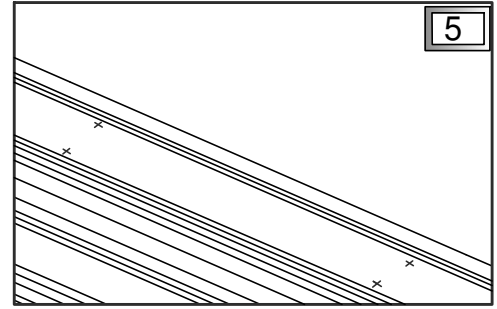
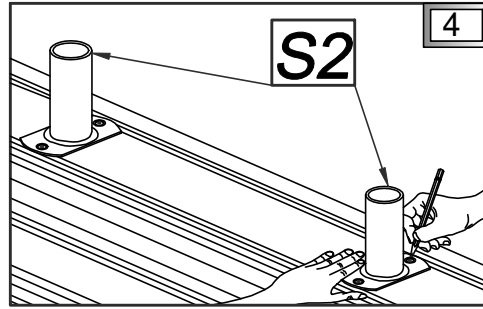
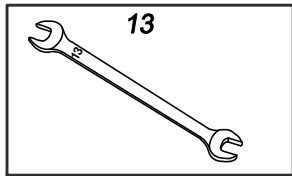
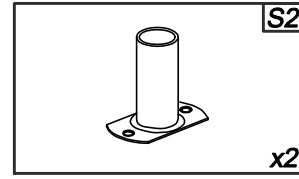
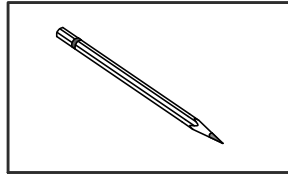
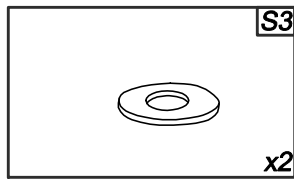
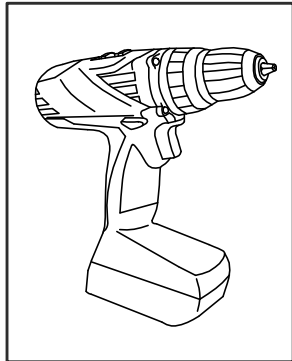

(PL) Maskownice

(GB) Corners covers

(D) Abdeckungen

(FR) Les caches

(IT) Mascherini

(NL) Afdekkappen



(PL) Montaż maskownic (Y) do desek tarasowych.

(FR) Le montage des caches (Y) pour les margelles.

(GB) Mounting covers (Y) for corners of terrace boards.

(IT) Montaggio di mascherini (Y) per le tavole da terrazza.

(D) Montage der Abdeckungen (Y) ans Terrassenholz.

(NL) Roest vrij afdekkappen (Y) voor de hoeken van de boven rand.

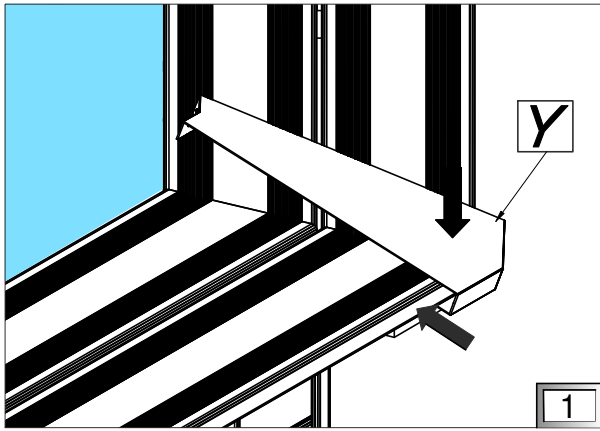
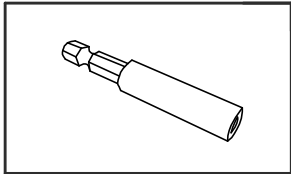
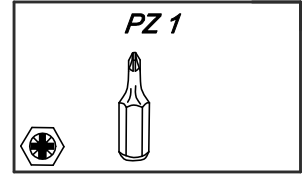
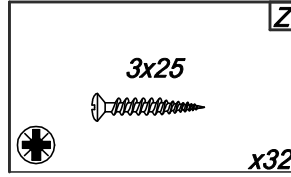
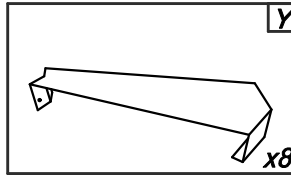
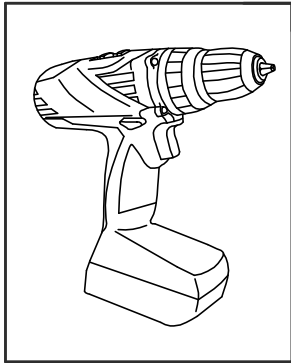

1

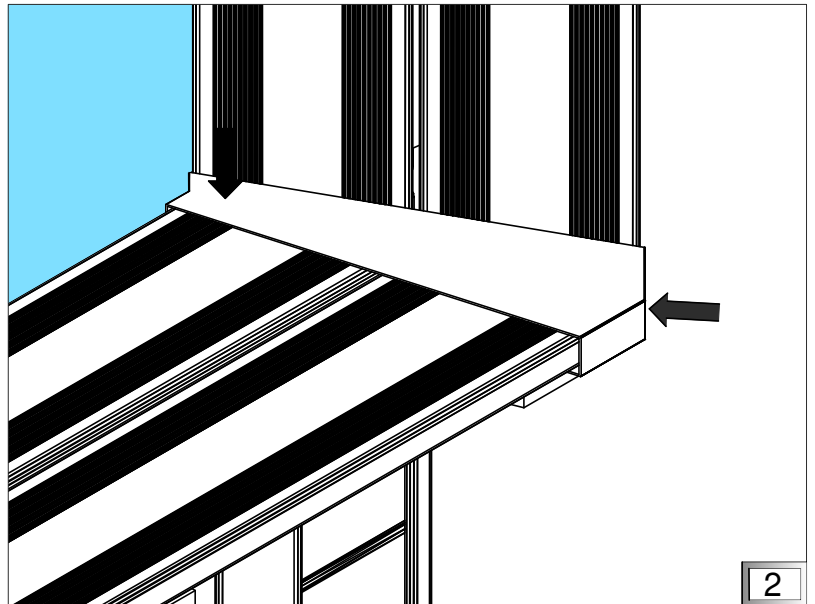

2

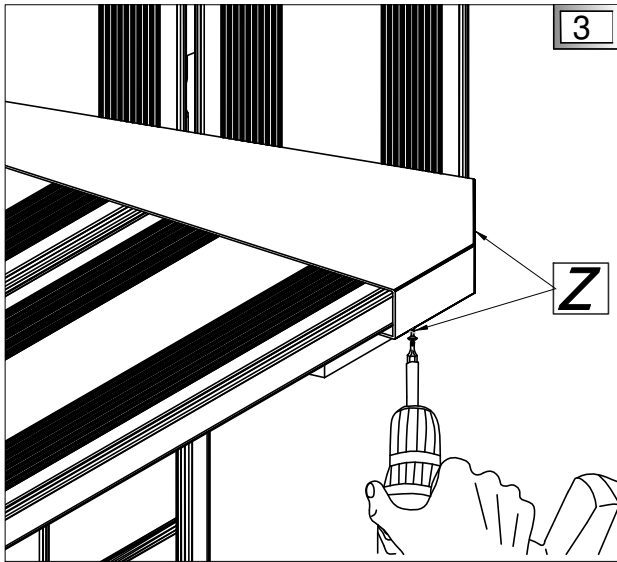

3

Z

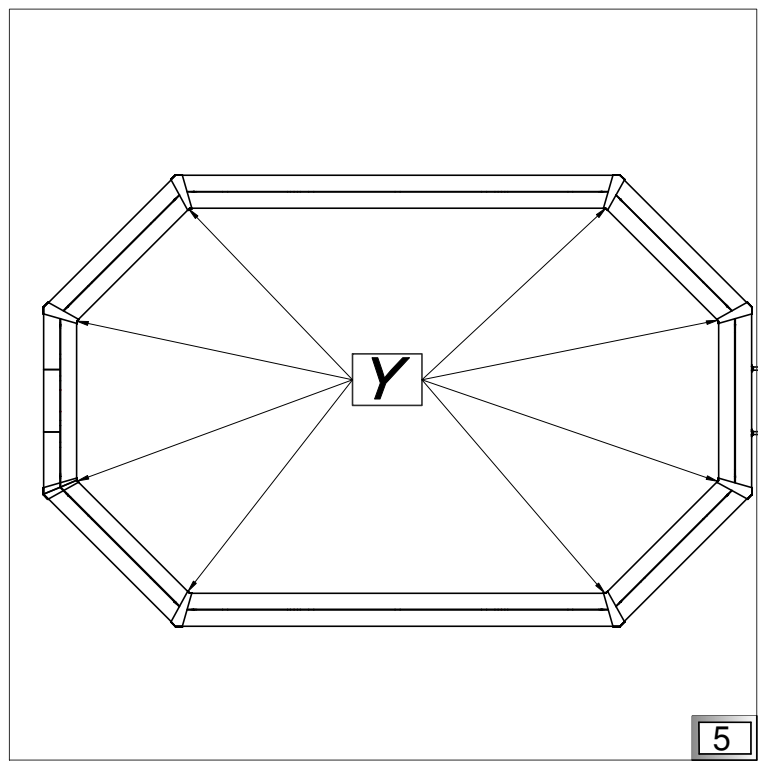

5

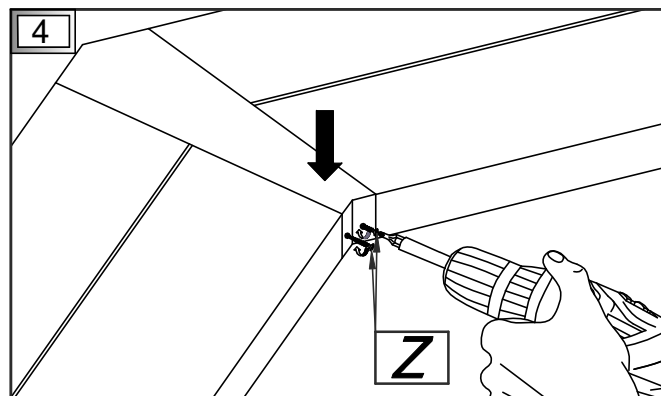

4

Z