

PL Instrukcja montażu

GB Assembly instructions

DE Montageanleitung

FR Notice de montage

IT Istruzioni di montaggio

NL Montage-instructies

Nazwa /Name /Name /Nom /Nome /Namm

PUMPENHAUS

Holzdicke: 14 mm
Holzsorte: Nordische Kiefer
Schutz: Klasse 4 Imprägnierung
Beschlag Material:: Zink/ Edelstahl

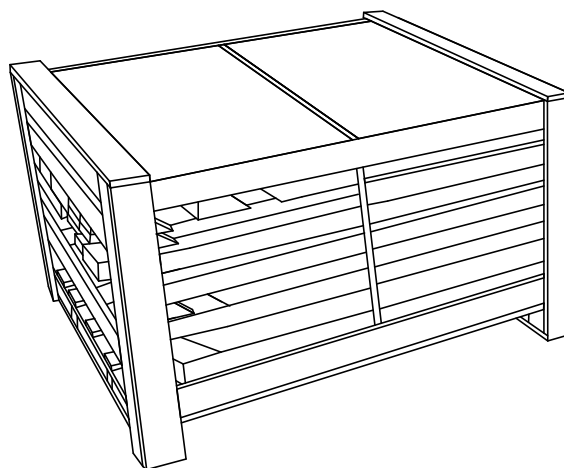
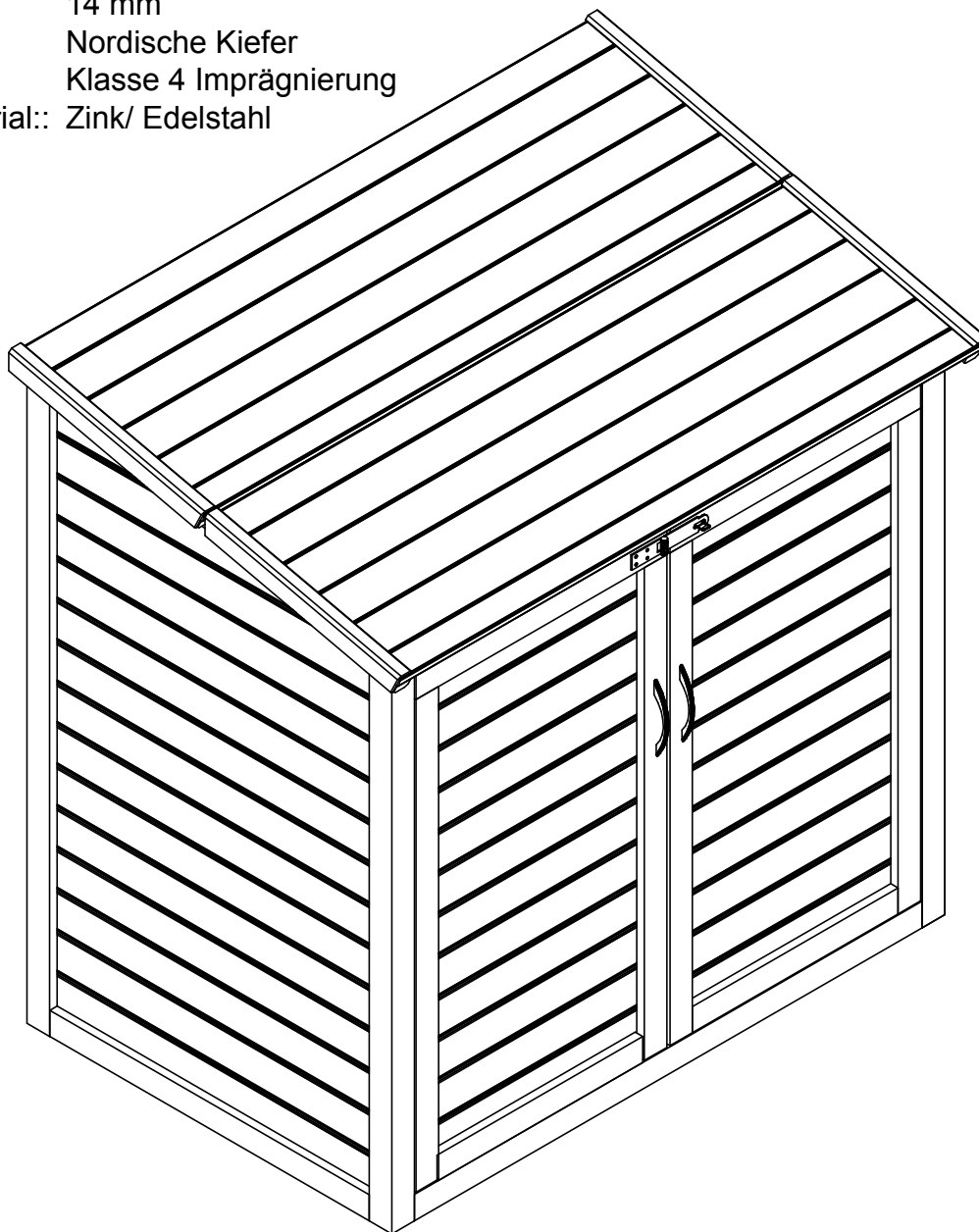

(PL) Instrukcja montażu

(GB) Assembly instructions

(DE) Montageanleitung

(FR) Notice de montage

(IT) Istruzioni di montaggio

(NL) Montage-instructies



(PL) Przed przystąpieniem do montażu zapoznaj się z instrukcją.

(FR) Avant le montage lisez attentivement la notice.

(GB) Read carefully assembly manual before the installation.

(IT) Prima del montaggio è necessario consultare il manuale.

(DE) Vor der Montage machen Sie sich bitte mit der Bedienungsanleitung bekannt.

(NL) Lees aandachtig de montage instructie van het zwembad voor de installatie.

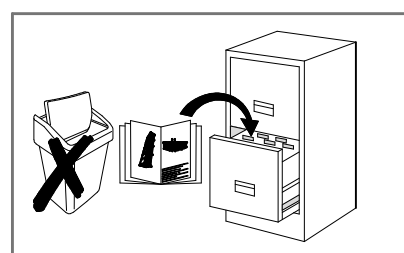
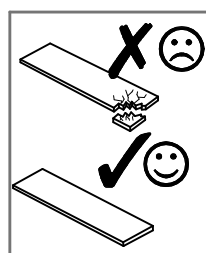
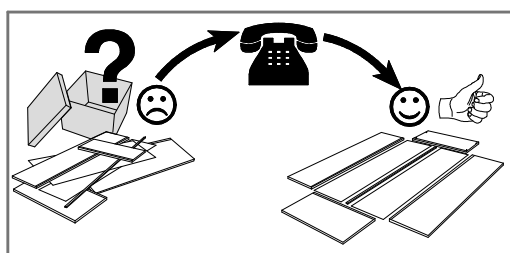
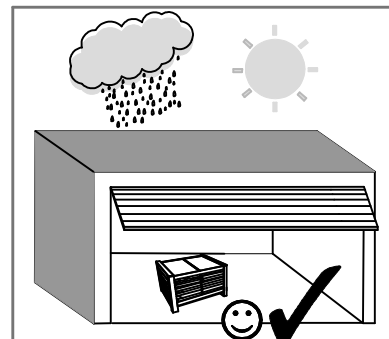
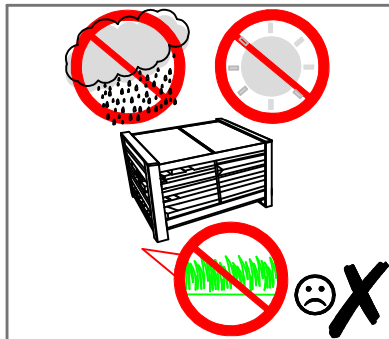
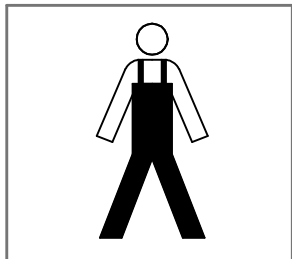
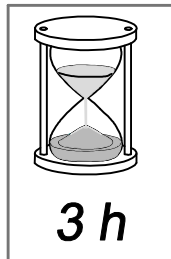

UWAGA / ATTENTION / NOTE / ATENZIONE / HINWEIS / LETOP

(PL) Montaż wykonać w przeciągu 3 dni od rozpakowania struktury.

(FR) Il faut monter la structure au cours de 3 jours de l'ouverture du colis.

(GB) Installation should be finished within 3 days from opening the package.

(IT) Il montaggio effettuare entro 3 giorni dal disimballo della struttura.

(DE) Die Montage ist innerhalb von 3 Tagen zu machen, nachdem die Konstruktion geöffnet wird.

(NL) De installatie moet worden afgewerkt binnen 3 dagen na het openen van de verpakking.

UWAGA / ATTENTION / NOTE / ATENZIONE / HINWEIS / LETOP

(PL) Brak corocznej konserwacji struktury powoduje utratę gwarancji.

(FR) Le manque de la conseravtion annuelle de la structure cause la perte de la garantie.

(GB) Lack of once a year conservation of the structure causes loss of warranty.

(IT) Mancanza della manutenzione annuale causa la perdita di garanzia.

(DE) Keine jährliche Wartung der Konstruktion macht das, das die Garantie verloren geht.

(NL) Behandel elk jaar de buitenkant van het zwembad met een beits, anders vervalt de garantie.

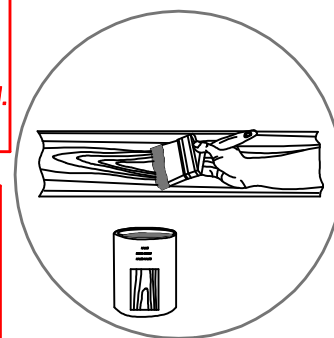

UWAGA / ATTENTION / NOTE / ATENZIONE / HINWEIS / LETOP

(PL) Nie pozostawiać dzieci bez nadzoru!

(FR) Ne laissez pas les enfants sans surveillance!

(GB) Do not leave children unattended!

(IT) Non lasciare bambini incustoditi!

(DE) Lassen Sie Kinder nicht unbeaufsichtigt!

(NL) Laat kinderen niet zonder toezicht!

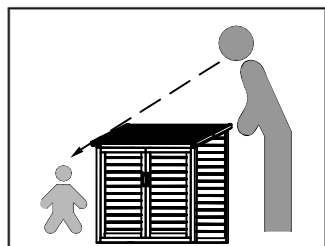

PL Elementy

GB Elements

DE Elemente

FR Les éléments

IT Elementi

NL Balken



- PL** Sprawdź ilość oraz czy elementy nie są uszkodzone.
- FR** Vérifiez la quantité et si les éléments ne sont pas abîmés.
- GB** Check quantity of elements and if they are not faulty.
- IT** Controllare la quantità e se gli elementi non sono danneggiati.
- DE** Überprüfen Sie die Menge, und ob die Elemente nicht beschädigt sind.
- NL** Controleer de aantal balken, en op eventuele beschadigingen.

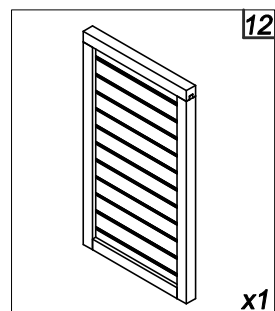
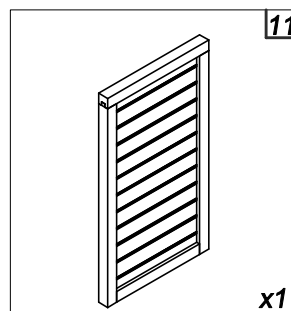
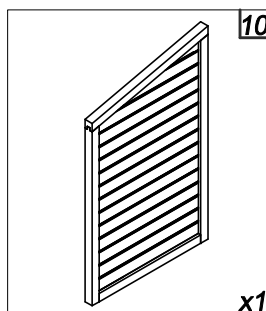
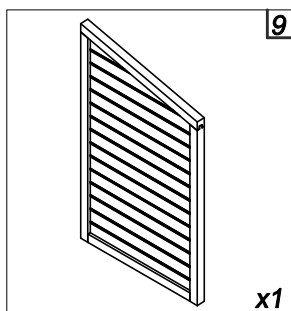
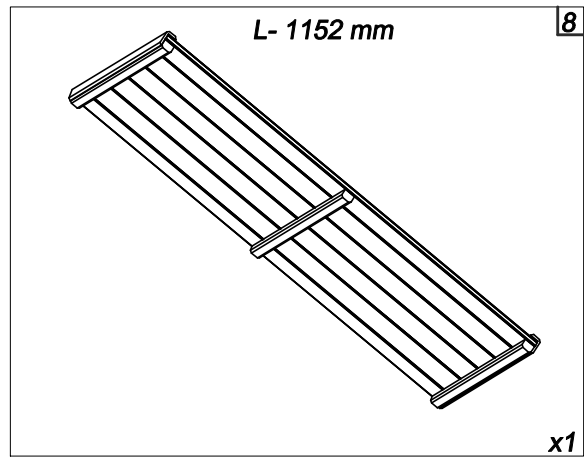
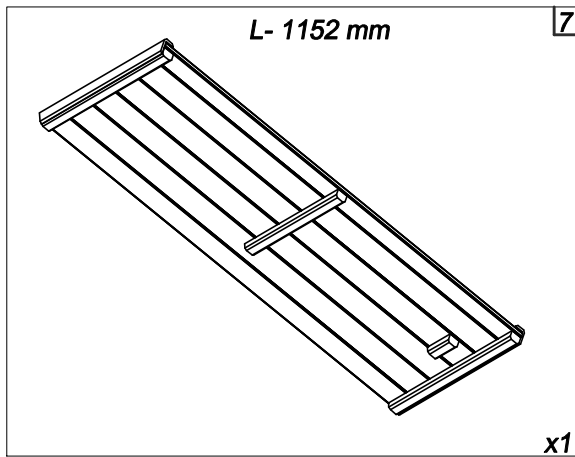
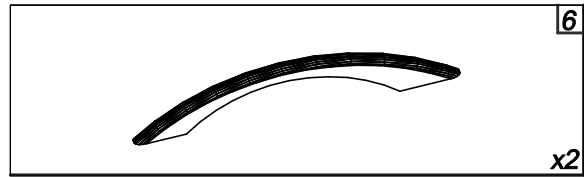
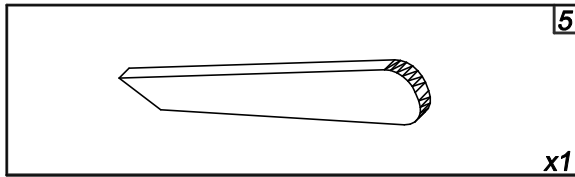
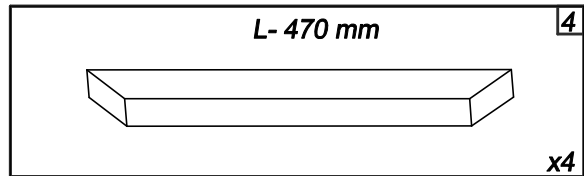
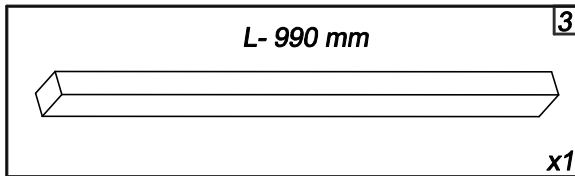
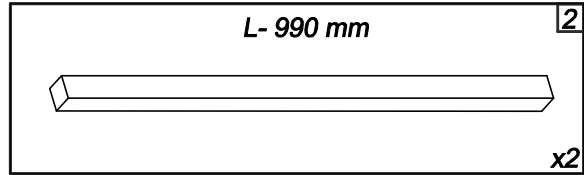
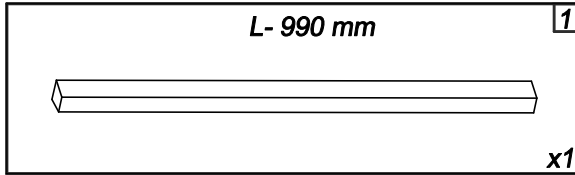
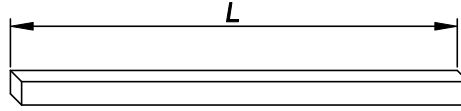

PL Okucia i osprzęt

GB Fittings and equipment

DE Beschläge und Ausrüstung

FR Quincaillerie et l'équipement

IT Ferramenti e accessori

NL Bouwmaterialen



PL Sprawdź ilość.

FR Vérifiez la quantité.

GB Check quantity.

IT Controllare la quantità.

DE Überprüfen Sie die Menge.

NL Controleer het aantal.

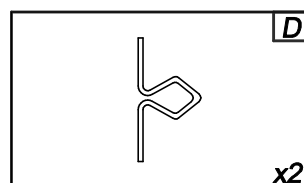
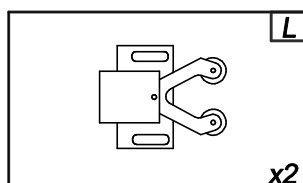
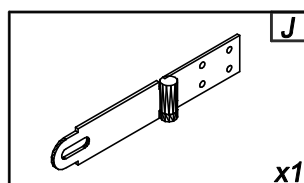
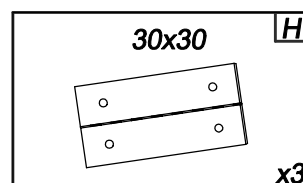
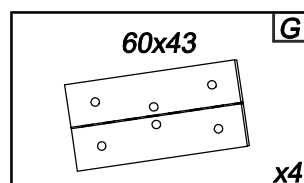
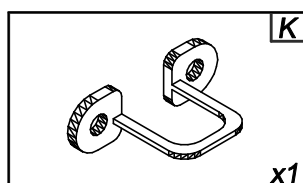
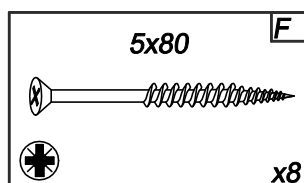
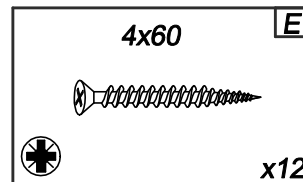
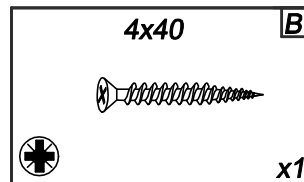
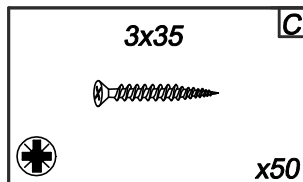
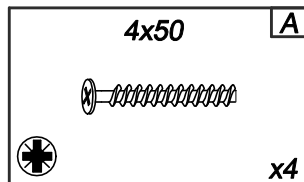

PL Przygotuj niezbędne narzędzia - niezawarte w zestawie

IT Preparare gli strumenti necessari - non inclusi nel set.

FR Préparez les outils nécessaires - pas inclus.

DE Bereiten Sie notwendiges, nicht im Satz enthaltenes Werkzeug vor.

GB Prepare essential tools - not included.

NL Benodigd gereedschap - niet inbegrepen.

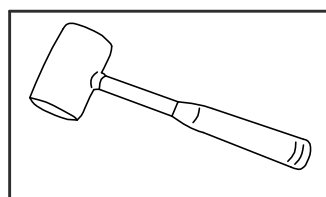
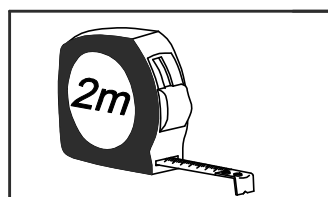
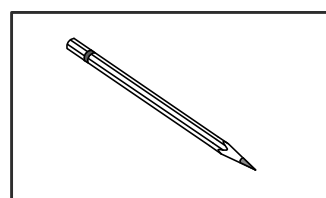
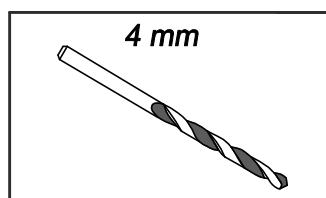
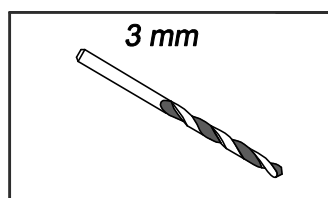
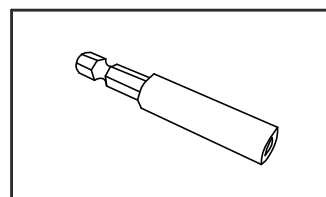
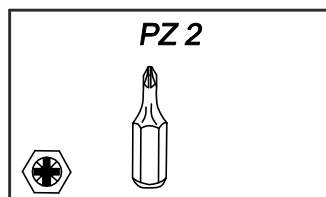
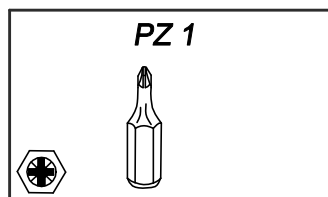
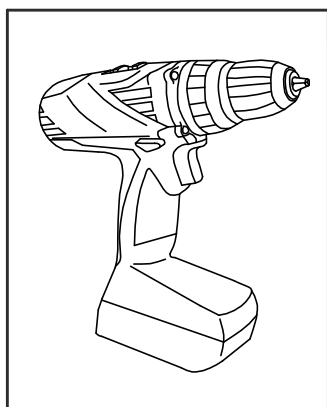

(PL) Struktura drewniana

(GB) Wooden structure

(DE) Holzstruktur

(FR) La structure bois

(IT) Struttura in legno

(NL) Houten structuur

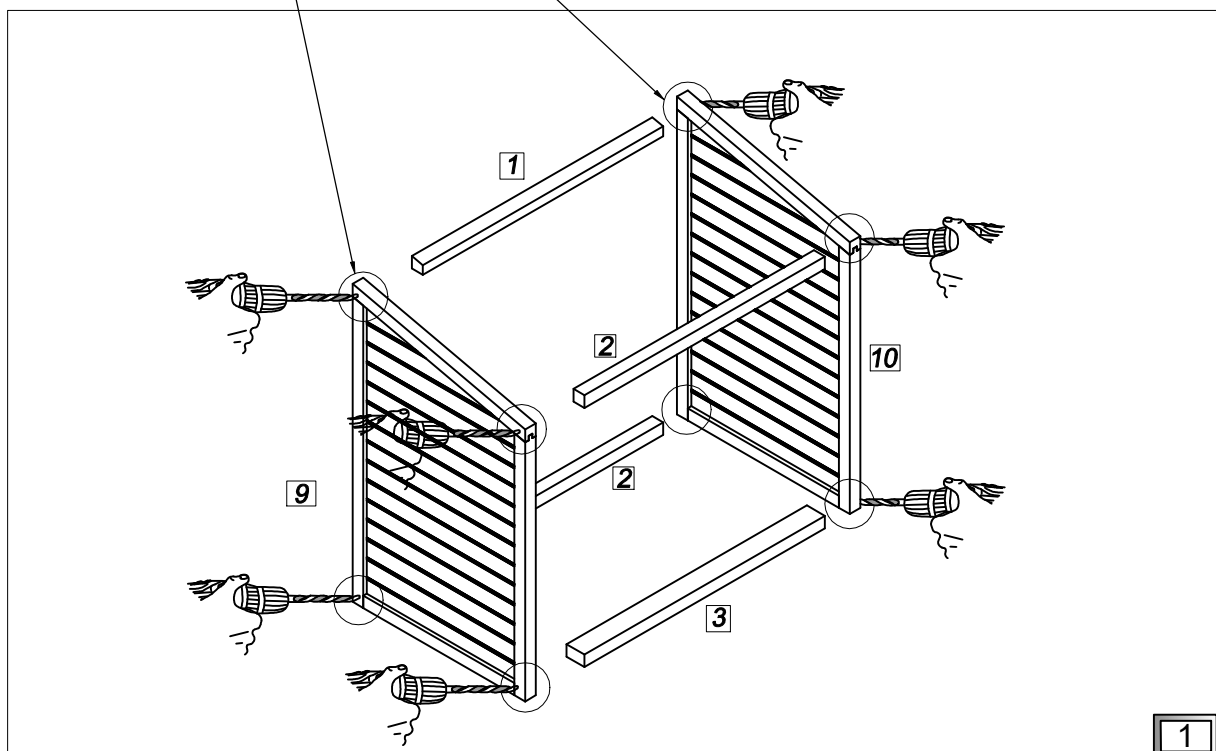
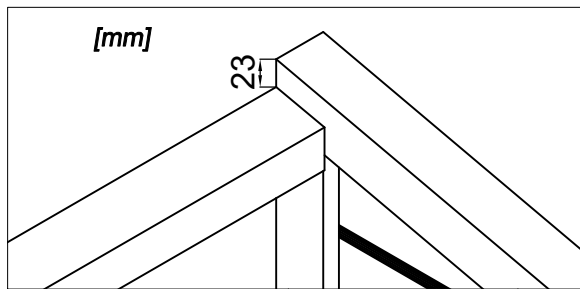
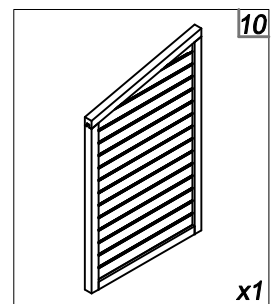
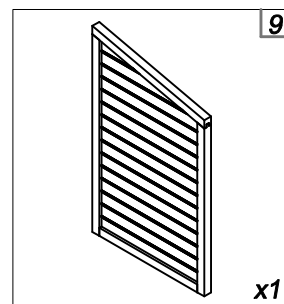
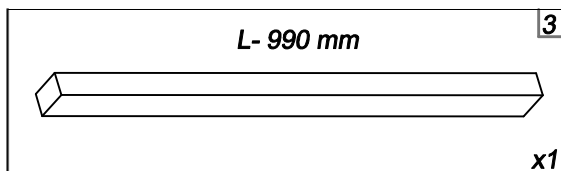
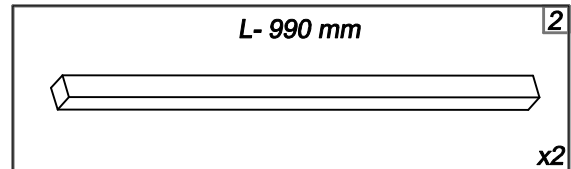
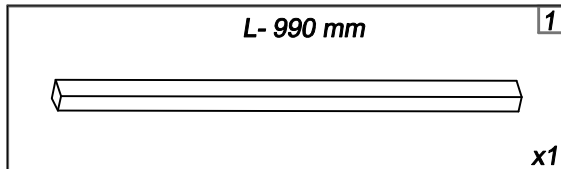
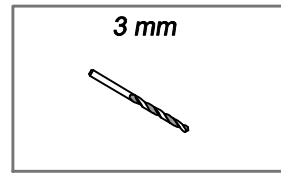
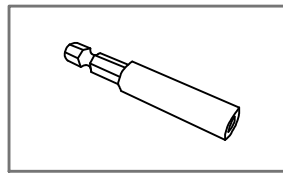
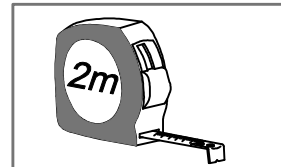
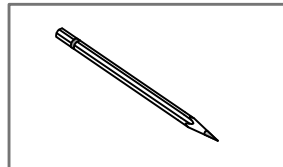
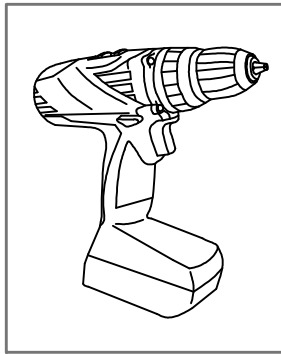

(PL) Struktura drewniana

(GB) Wooden structure

(DE) Holzstruktur

(FR) La structure bois

(IT) Struttura in legno

(NL) Houten structuur

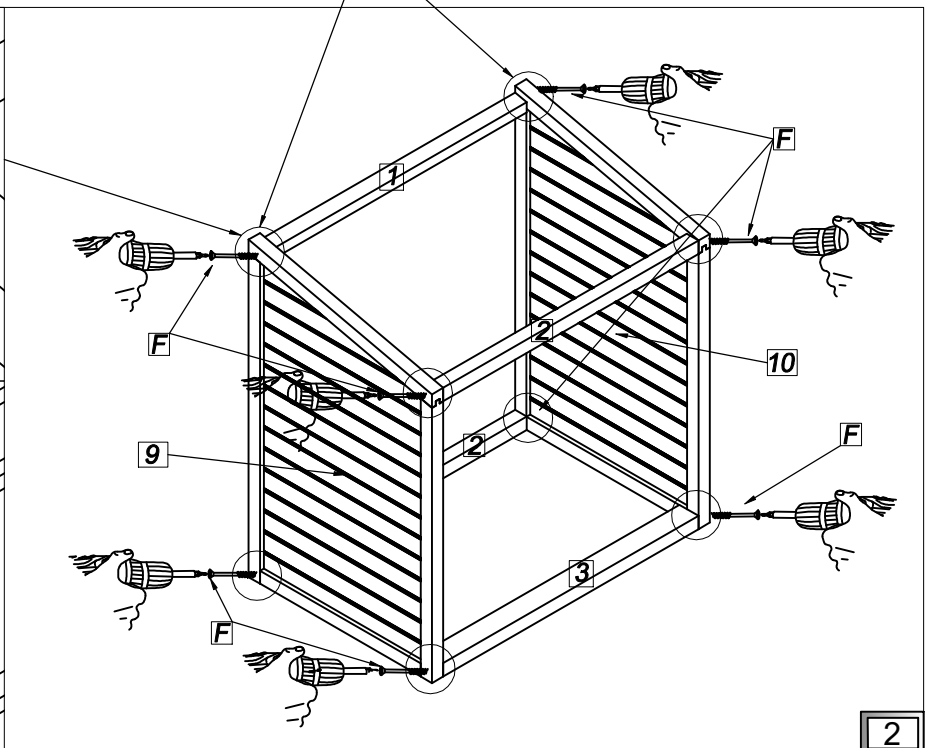
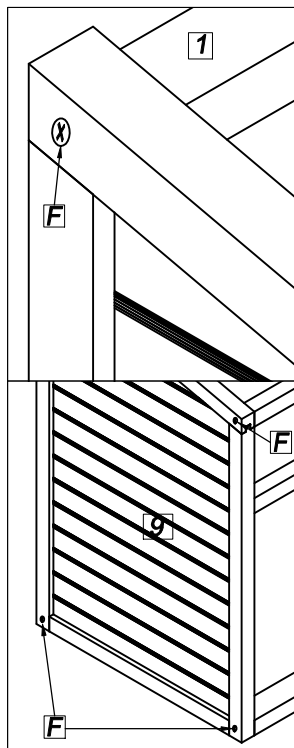
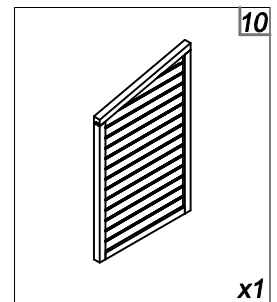
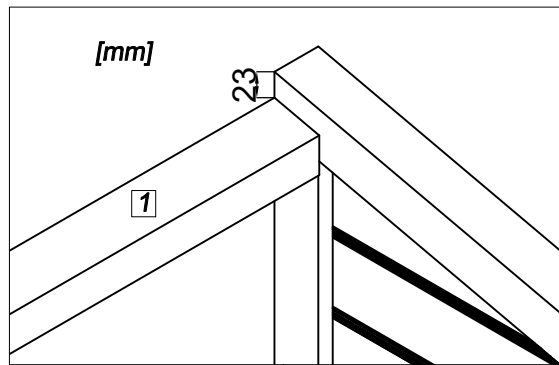
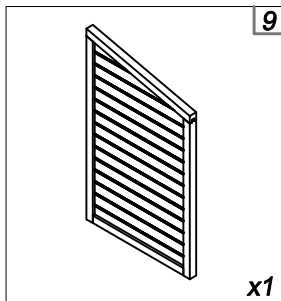
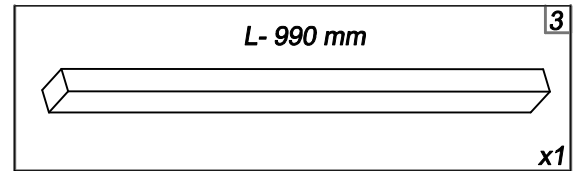
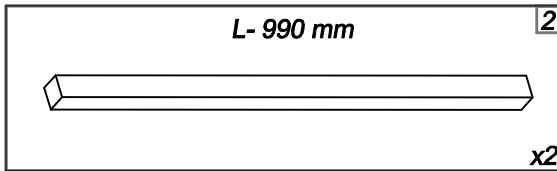
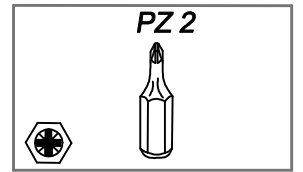
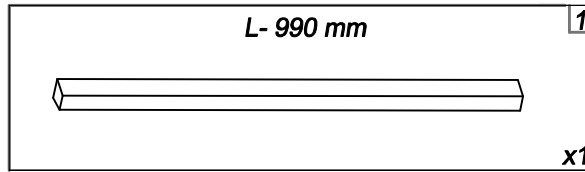
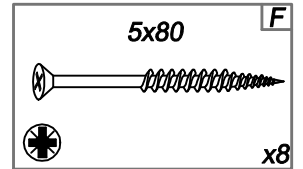
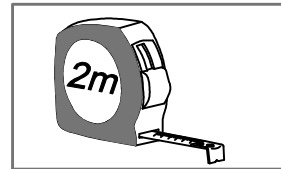
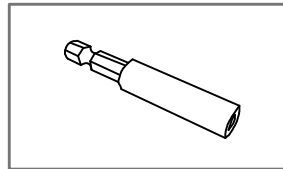
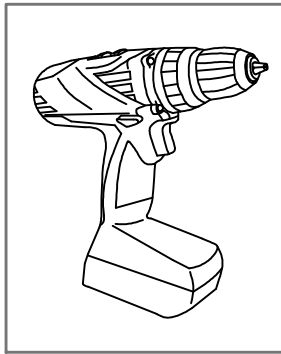

PL Struktura drewniana

GB Wooden structure

DE Holzstruktur

FR La structure bois

IT Struttura in legno

NL Houten structuur

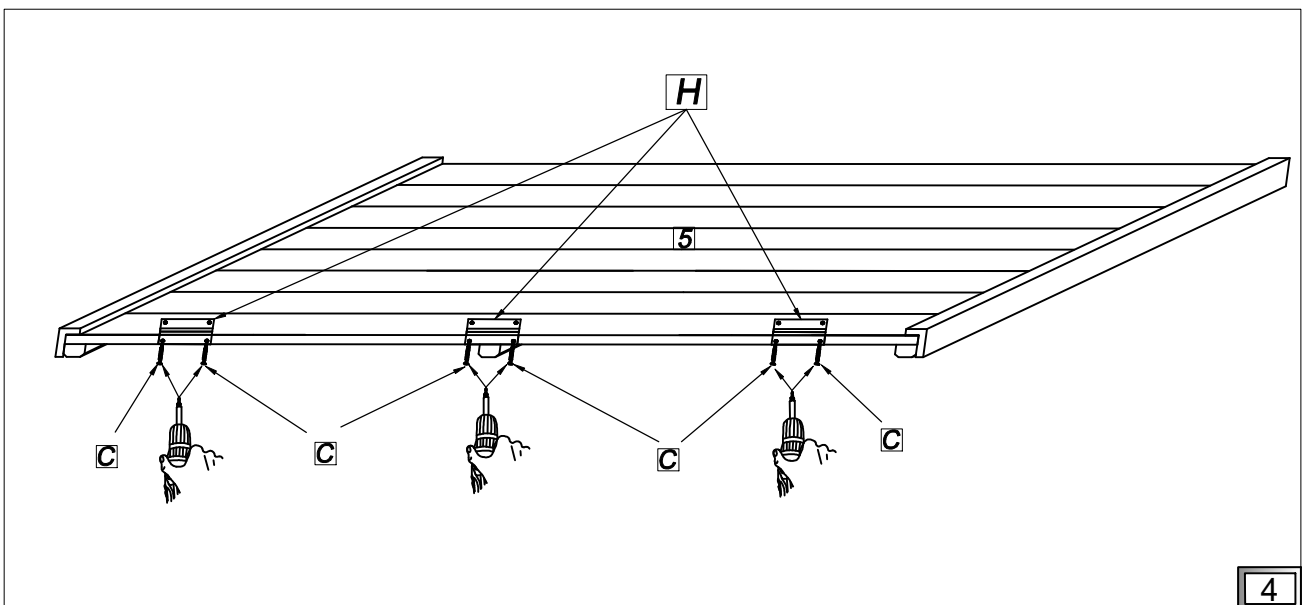
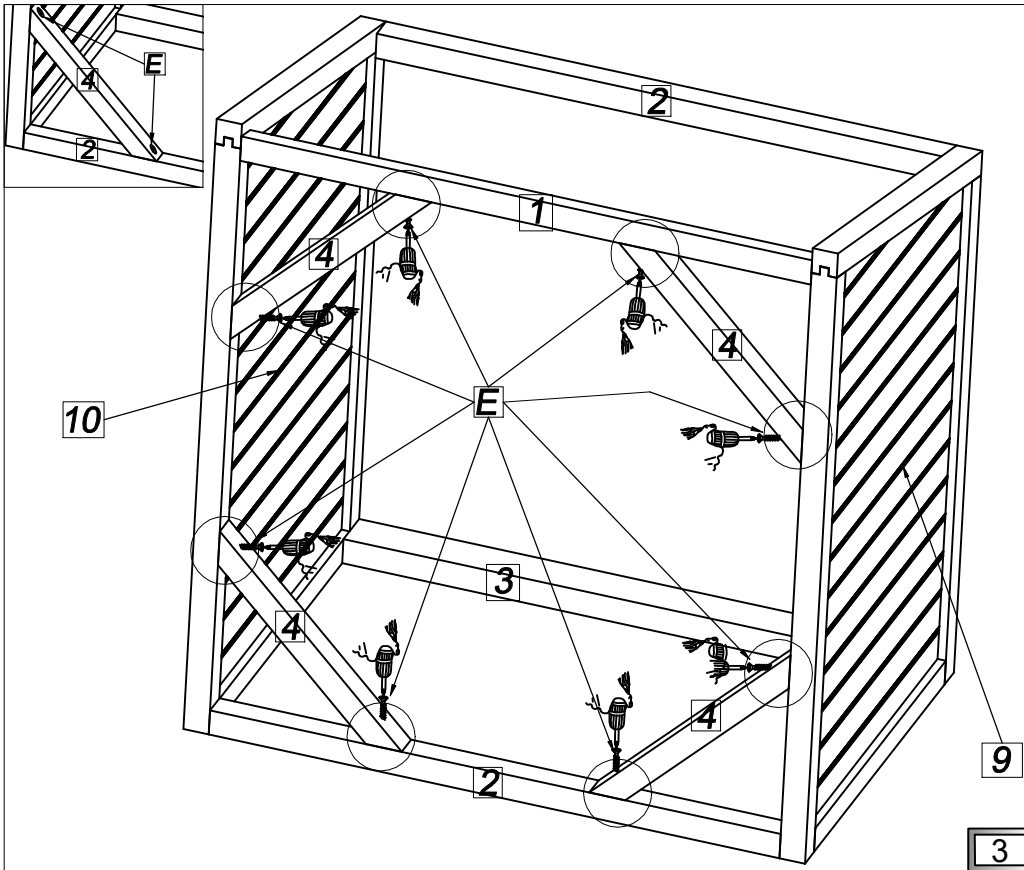
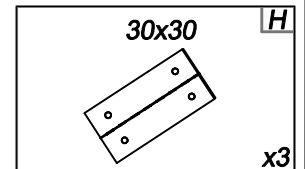
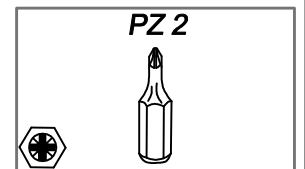
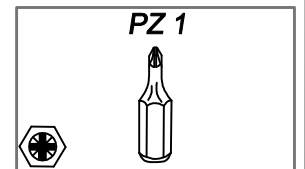
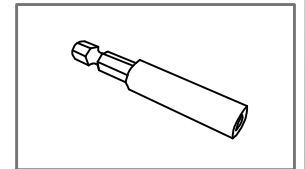
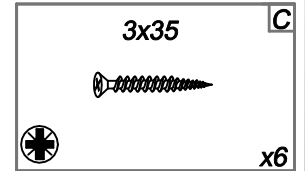
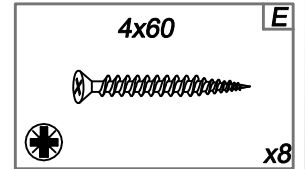
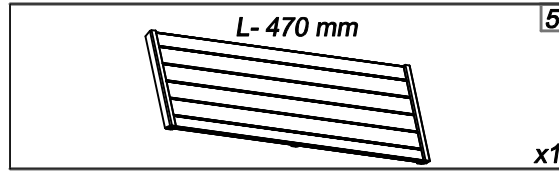
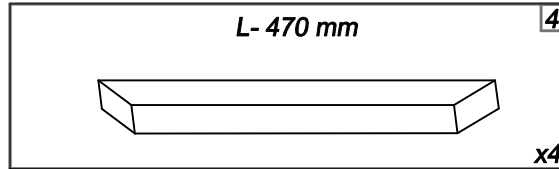
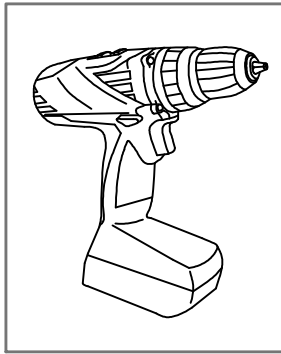

PL Struktura drewniana

GB Wooden structure

DE Holzstruktur

FR La structure bois

IT Struttura in legno

NL Houten structuur

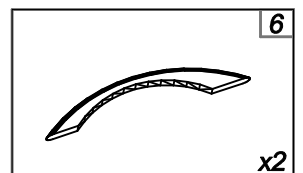
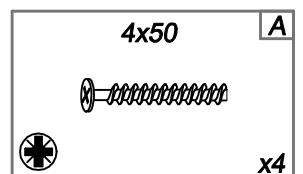
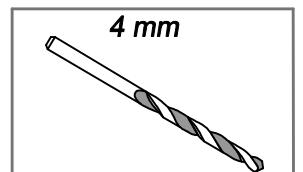
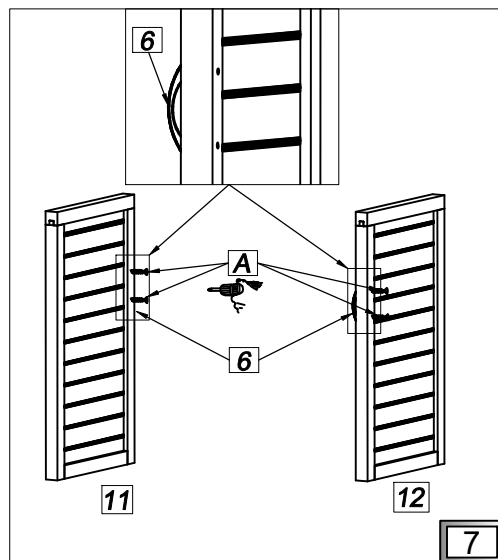
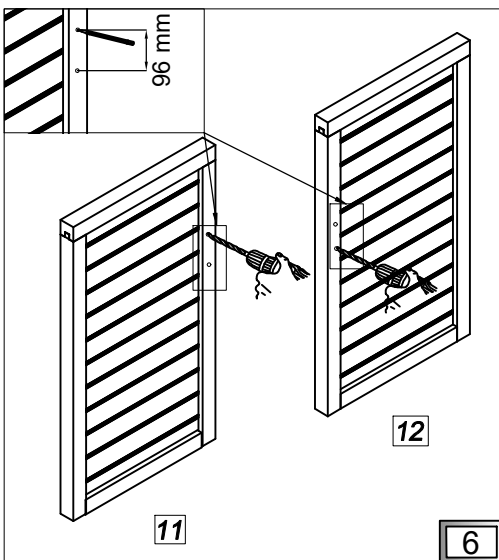
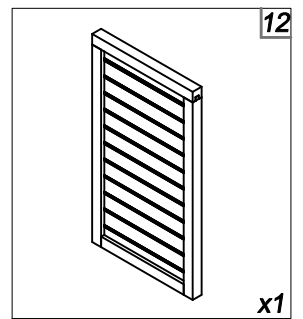
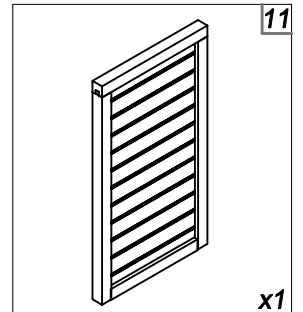
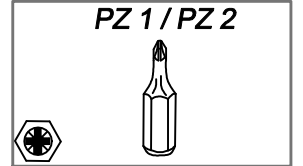
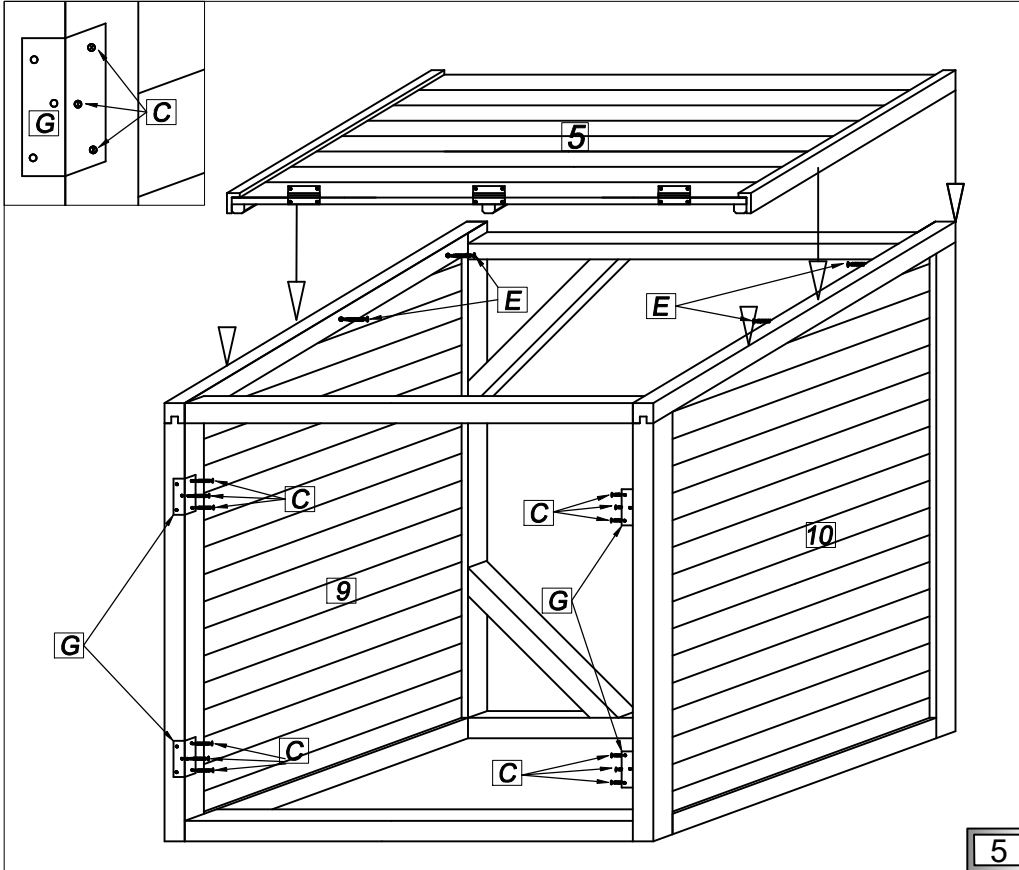
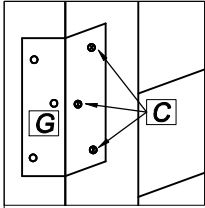
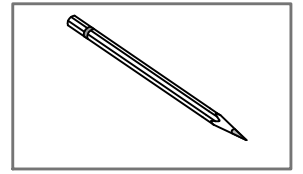
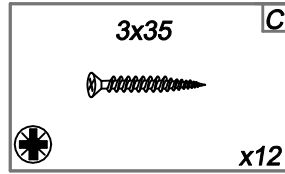
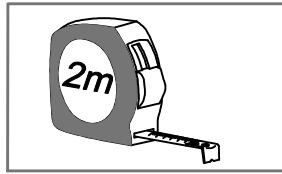
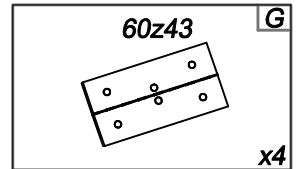
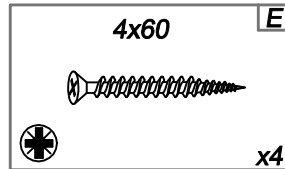
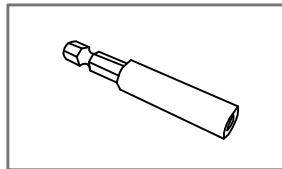
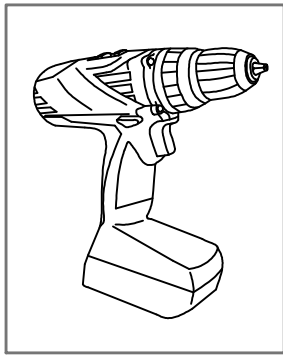

(PL) Struktura drewniana

(GB) Wooden structure

(DE) Holzstruktur

(FR) La structure bois

(IT) Struttura in legno

(NL) Houten structuur

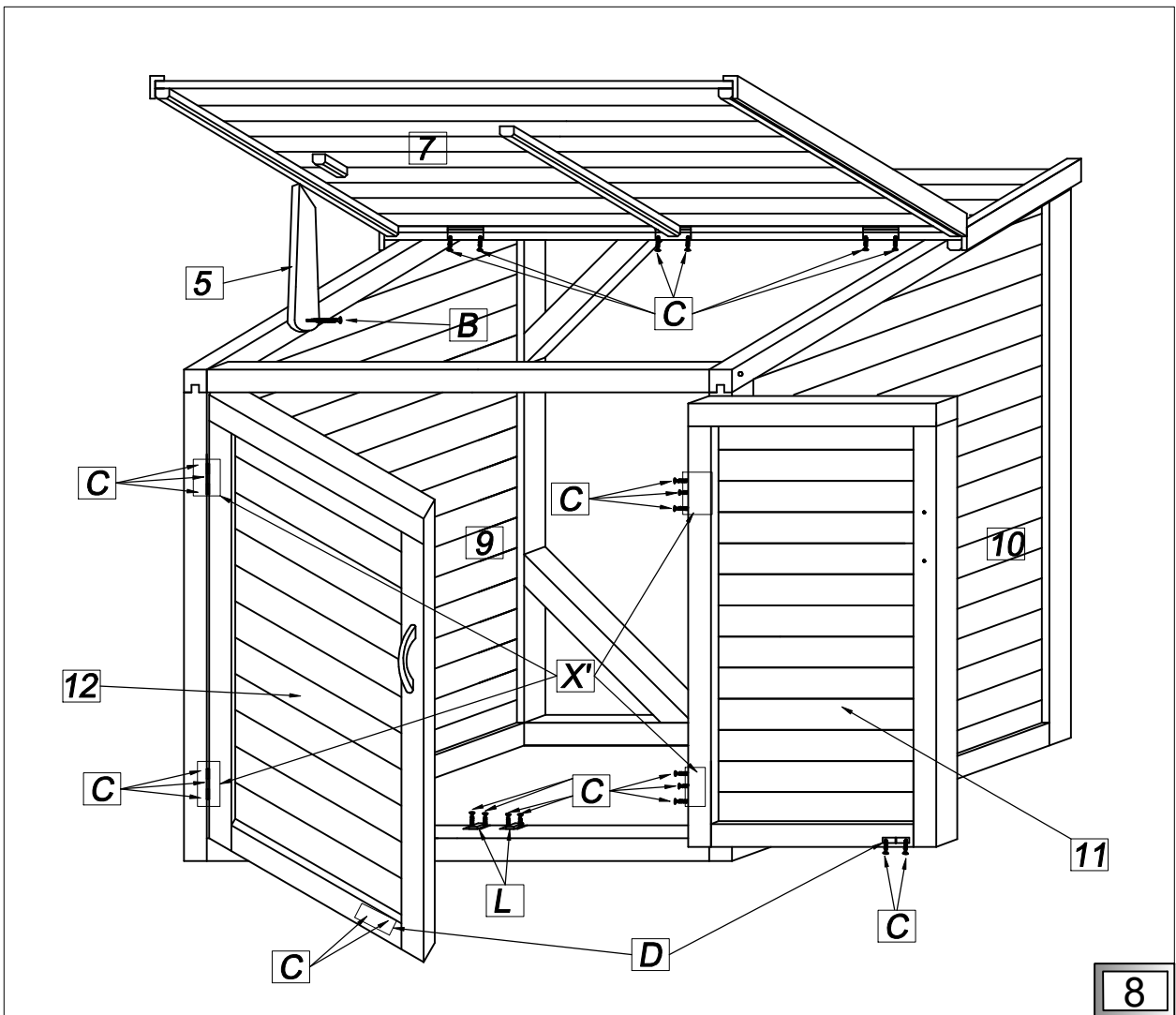
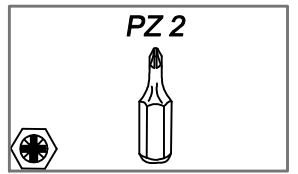
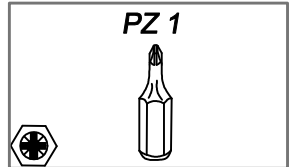
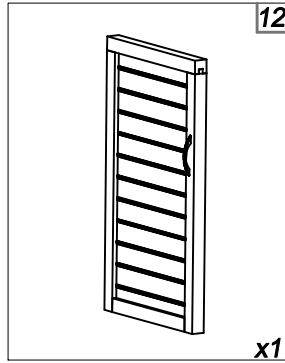
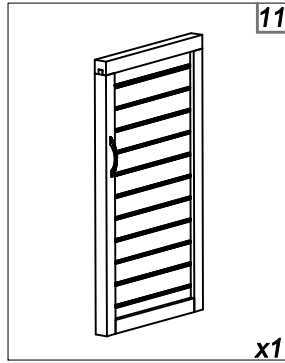
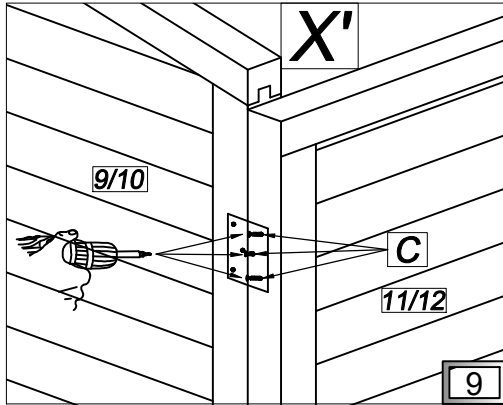
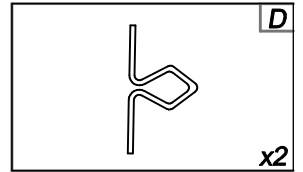
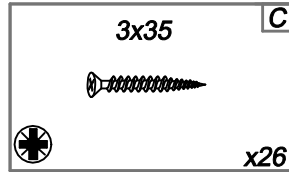
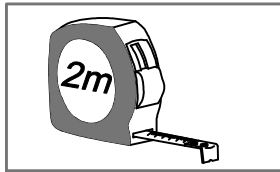
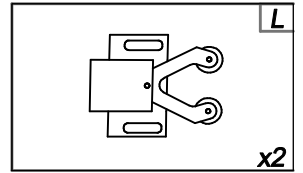
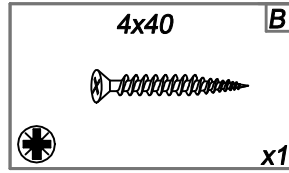
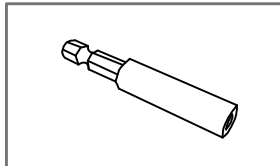
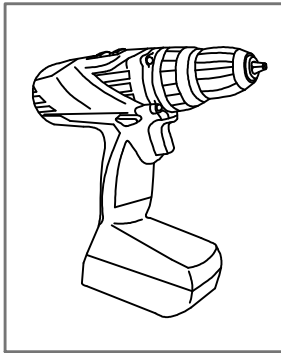

(PL) Struktura drewniana

(GB) Wooden structure

(DE) Holzstruktur

(FR) La structure bois

(IT) Struttura in legno

(NL) Houten structuur

